

# DECstation 5000 Model 240

---

## Hardware Installation Guide

**digital**<sup>™</sup>

EK-PM38A-IN-001

digital equipment corporation  
maynard, massachusetts

# Parts of the Basic Workstation

The basic workstation includes the following items:

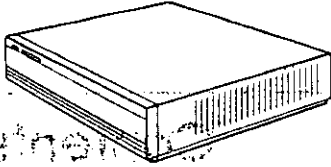

System unit



Keyboard with cable  
(Keyboard ordered may differ from the one shown.)

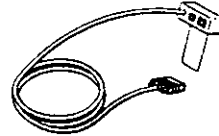

Keyboard-mouse cable assembly

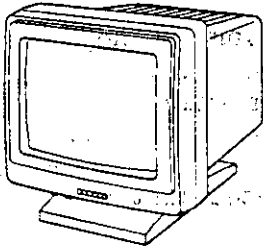

Monitor



Mouse with cable



System-unit-to-expansion-box cable



Antistatic wrist strap



Monitor-to-system-unit power cable

One of these three video cable assemblies:



Gray-scale video cable assembly



Screwdrivers



System unit power cord  
(This may need to be ordered separately out side of the U.S.A.)



Color video cable assembly



Communication connector adapter



Monochrome video cable assembly



ThickWire Ethernet loopback connector



Monitor power cord  
(This may need to be ordered separately out side of the U.S.A.)

WS3PI057

# Contents

Step 1—Open each box of your workstation shipment and identify its contents. . . . .	1
Step 2—Find and organize all workstation hardware documentation. . . . .	2
Step 3—Set up the system unit. . . . .	2
Step 4—Install any internal options in the system unit or expansion boxes. . . . .	7
Step 5—Connect any external storage devices to the system unit. . . . .	9
Step 6—Set up the monitor. . . . .	21
Step 7—Connect the monitor video cable. . . . .	24
To connect a color monitor video cable . . . . .	24
To connect a gray scale monitor video cable . . . . .	27
To connect a monochrome monitor video cable . . . . .	30
Step 8—Connect the monitor to a power source. . . . .	33
Step 9—Connect the keyboard and the mouse or tablet to the system unit. . . . .	35
Step 10—Connect any communication devices to the system unit. . . . .	39
Step 11—Turn on and test the workstation. . . . .	39
Step 12—Check to see if your workstation recognizes all internal option modules. . . . .	43
Step 13—Find and report your Ethernet station address. . . . .	46
Step 14—Check to see if your workstation recognizes all external storage devices. . . . .	47
Step 15—Install the worksystem software. . . . .	48
To install the worksystem software from a network . . . . .	49
To install the worksystem software from a tape drive . . . . .	49
To install the worksystem software from a compact disc drive . . . . .	56

# Figures

1	Front of the system unit	2
2	Back of the system unit	3
3	Icons on the system unit	3
4	ThickWire Ethernet loopback connector	4
5	Connecting a ThickWire Ethernet loopback connector to the system unit	4
6	Voltage labels	5
7	On/off switch in the off position	5
8	Connecting the system unit power cord to the system unit	6
9	Removing and replacing the system unit cover	8
10	On/off switch in the off position	11
11	System-unit-to-expansion-box cable	12
12	Attaching the smaller connector on the system-unit-to-expansion-box cable to the SCSI connector on the system unit	13
13	Attaching the system-unit-to-expansion-box cable to the non-TCE box closest to the system unit	14
14	SCSI box-to-box cable	15
15	Connecting additional non-TCE expansion boxes	16
16	TCE-to-expansion-box cable	17
17	Connecting the TCE-to-expansion-box cable to the SCSI connector	18
18	Attaching a SCSI drive terminator	19
19	Connecting the power cords	20
20	Video connectors	22
21	Monitor example	23
22	Monitor on/off switches	23
23	Color video cable assembly	24
24	Connecting a video cable assembly to a color monitor	25
25	Connecting a 3-pin cable connector to the system unit	26
26	Gray scale video cable assembly	27
27	Connecting a video cable assembly to a gray scale monitor	28
28	Connecting a gray scale video cable assembly to the system unit	29
29	Monochrome video cable assembly	30
30	Connecting a video cable assembly to a monochrome monitor	31

31	Connecting a monochrome video cable assembly to the system unit .....	29132
32	Monitor-to-system-unit power cable and monitor power cord .....	33
33	Connecting the monitor-to-system-unit power cable .....	34
34	Turning on the monitor .....	34
35	Keyboard-mouse cable assembly .....	35
36	Connecting the keyboard-mouse cable assembly to the system unit .....	36
37	Connecting the keyboard cable to the connector block .....	37
38	Positioning the connector block .....	38
39	Turning on the system unit .....	40
40	ULTRIX software installation tape cartridge .....	49
41	Opening the door to the tape drive .....	50
42	Power switch and indicator lights on tape drive .....	51
43	Lifting the cartridge insert/release handle .....	52
44	Inserting the tape cartridge .....	53
45	Lowering the cartridge insert/release handle .....	54
46	Loading the software installation compact disc .....	56

## Tables

1	Usual SCSI ID Assignments for External Drives .....	10
2	Base System and TURBOchannel Option Module Codes .....	44
3	Device Codes for Different Types of SCSI Drives .....	48

## Step 1—Open each box of your workstation shipment and identify its contents.

1. Keep together all hardware, cables, and power cords that came in the same carton.

*Caution: Do not remove internal option modules from their antistatic bags until you are ready to install them. Handling a module without first attaching an antistatic wrist strap can damage the module.*

2. Identify the items in each box, using the packing list that came with your shipment, the “Parts of the Basic Workstation” figure on page ii of this guide, and the following general list.

The basic workstation includes

- System unit
- Monitor
- Keyboard
- Mouse
- Associated cables, power cords, and connectors

In addition to these components, your workstation shipment should include

- Any internal option modules you ordered
- Any external storage devices (tape, disk, or compact disc drives) you ordered
- Cables, power cords, and connectors for the optional items you ordered
- Any software you ordered
- User documentation for the basic workstation
- Documentation for the optional hardware you ordered
- Documentation for the software you ordered

Each workstation component comes with its own set of required and optional cables and connectors. This may result in some duplicate items in your shipment that you will not use.

## Step 2—Find and organize all workstation hardware documentation.

Find the following hardware documentation for your basic workstation, organize it, and put it into the hardware documentation binder, separated by tabs:

- *DECstation 5000 Model 240 Hardware Installation Guide*
- *DECstation 5000 Model 240 Hardware Operator's Guide*
- *TURBOchannel Options User's Guide*, if included

Locate and organize any other hardware documentation that was shipped with your workstation components:

- Documentation for any external storage devices you ordered
- Documentation for any external communications devices you ordered
- Any other hardware documentation

## Step 3—Set up the system unit.

**Caution:** *It takes two people to unpack the system unit safely.*

1. Place the system unit flat on a level surface.

**Caution:** *Standing the system unit on its side blocks the cooling vents and can damage the unit by causing it to overheat.*

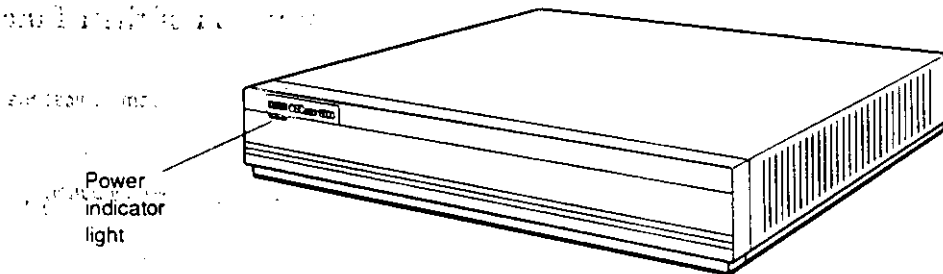

WS3P1098

Figure 1. Front of the system unit

2. Locate the three TURBOchannel option slots, the five base system connectors, the diagnostic LED display, the halt button, and the on/off switch on the back of the system unit.

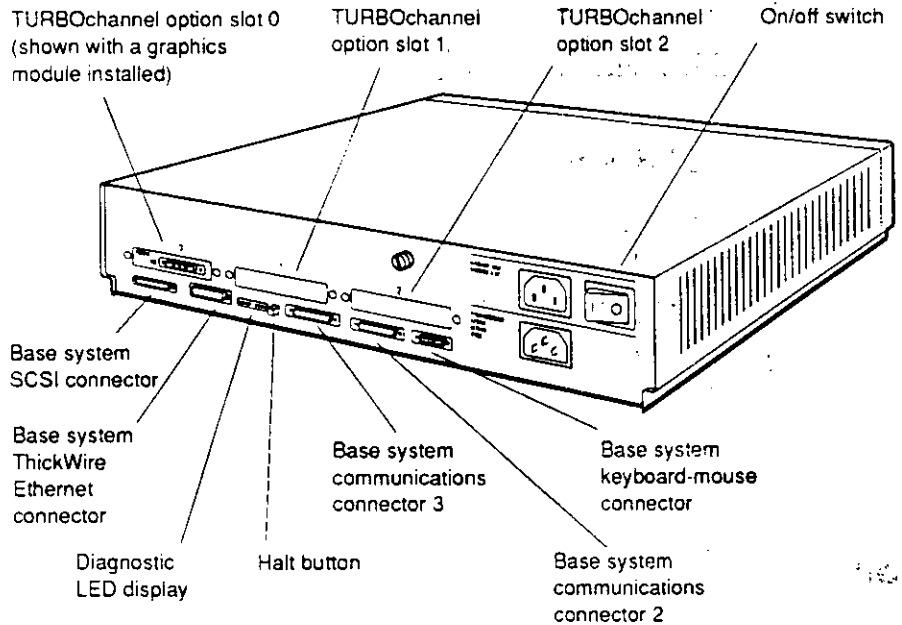

WS3PI009

**Figure 2. Back of the system unit**

The connectors on the back of the system unit are labeled with the following icons to remind you of their functions:

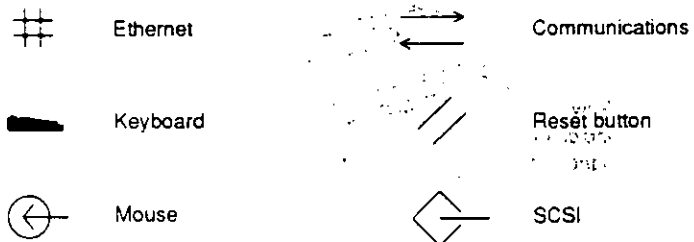

WS3PI097

**Figure 3. Icons on the system unit**



3. Find the ThickWire Ethernet loopback connector that came with your workstation.

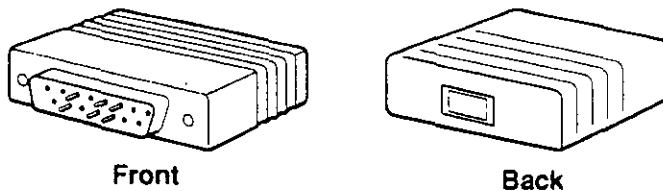

WS3PI030

**Figure 4. ThickWire Ethernet loopback connector**

4. Hold the ThickWire Ethernet loopback connector so the widest part of the metal connector frame is on top and push the connector directly into the ThickWire connector on the base system unit.

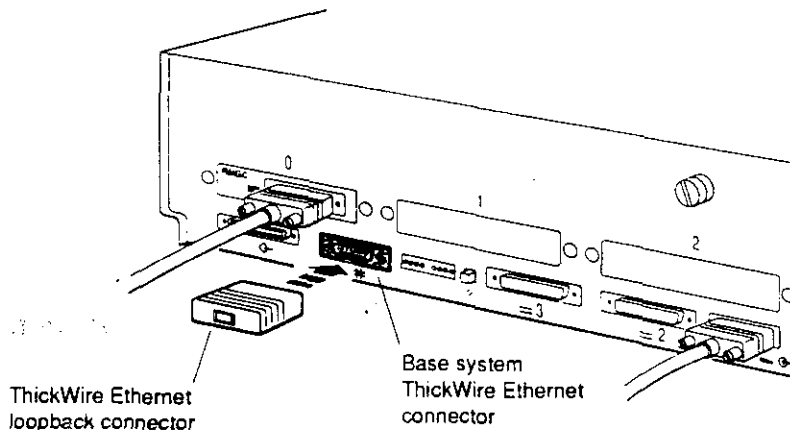

WS3PI031

**Figure 5. Connecting a ThickWire Ethernet loopback connector to the system unit**

5. If you have any Ethernet controller options in the TURBOchannel option slots, put Ethernet loopback connectors on these connectors also. (The workstation comes with only one Ethernet loopback connector. An extra loopback connector must be ordered for each Ethernet controller option module you have in a TURBOchannel option slot.)

**Caution:** *The workstation will not perform correctly unless all unused Ethernet connectors are properly terminated with loopback connectors.*

6. Check the voltage requirement labels printed on the back of the system unit (or check for a yellow voltage label covering the system unit power connector).

**Caution:** *Connecting a device to a power source that does not meet the voltage requirements of that device can damage the device.*

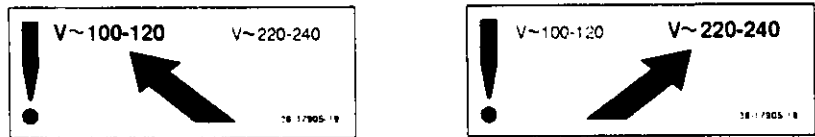

WS3PI007

Figure 6. Voltage labels

7. Make sure the on/off switch on the system unit is in the off position.

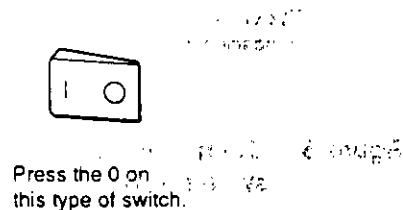

WS3PI034

Figure 7. On/off switch in the off position

8. Connect the appropriate end of the system unit power cord to the system unit power connector.

Do not plug the power cord into a power outlet until you have installed all of the other workstation components.

**Caution:** *Installing workstation components while the system unit is connected to a power source may damage the components if the power is on.*

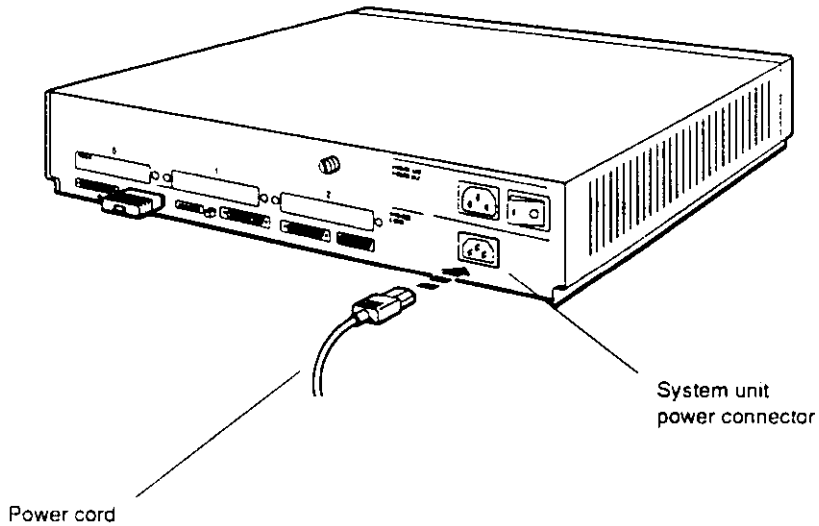

**Figure 8. Connecting the system unit power cord to the system unit**

## Step 4—Install any internal options in the system unit or expansion boxes.

Most workstations come with internal options preinstalled at the factory. Some options may be shipped separately and will need to be installed in the system unit or in an expansion box.

**Caution:** Always use an antistatic wrist strap when handling internal option modules. Touching the modules without antistatic protection can damage the modules.

1. If you need to install an internal tape, disk, or compact disc drive inside a BA42 expansion box, mark your place in this guide and refer to the appropriate section of the *BA42 Installation Guide*. Do not connect the BA42 box to the system unit yet.
2. If you need to install an internal tape, disk, or compact disc drive inside a TURBOchannel extender (TCE), mark your place in this guide and refer to the appropriate section of the *TURBOchannel Extender Operator's Guide*. Do not connect the TCE to the system unit or to an expansion box with a SCSI cable yet. Leave the TCE cover off for now if you also have TURBOchannel options to install in the TCE.
3. If you have memory modules, an NVRAM module, a CPU module, or any TURBOchannel option modules that you plan to install in the system unit, remove the system unit cover.
  - a. Loosen the captive screw on the back of the unit (it can be loosened, but not removed).
  - b. Stand in front of the unit, grasp both sides of the cover with your hands, and pull the cover straight toward you about 2 inches (6 centimeters). Then pull up.

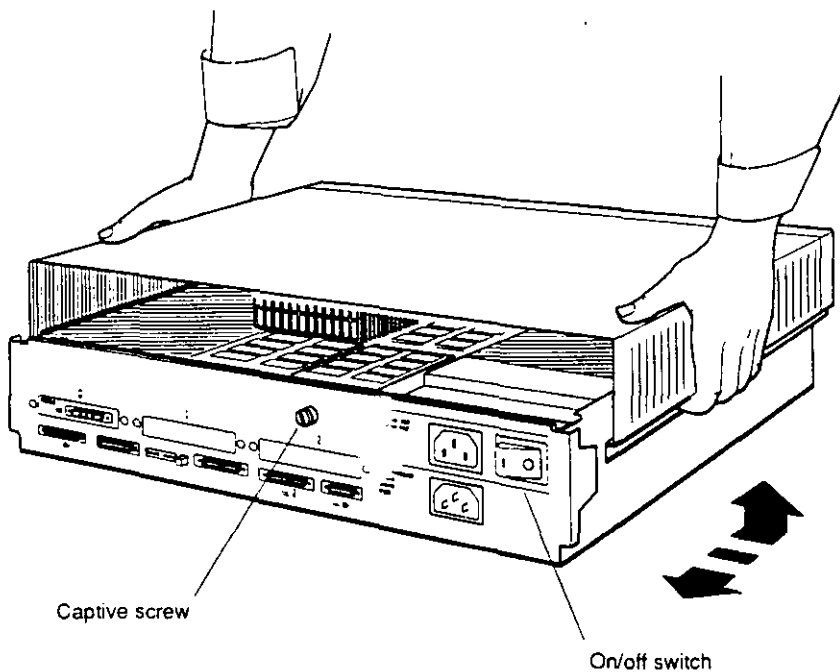

WS3PI099

**Figure 9. Removing and replacing the system unit cover**

4. If you need to install any memory modules, an NVRAM module, or a CPU module in the system unit, mark your place in this guide and refer to Chapter 9 of the *DECstation 5000 Model 240 Hardware Operator's Guide*. If you also have TURBOchannel option modules to install in the system unit, leave the system unit cover off and continue with the next step in this procedure.
5. If you have TURBOchannel option modules to install in the system unit, mark your place in this guide and refer to the appropriate chapter in the *TURBOchannel Options User's Guide* that tells you how to install that option.

If you are installing a TURBOchannel option module (such as a graphics module) inside a TURBOchannel extender, mark your place in this guide and refer to the appropriate section of the *TURBOchannel Extender Operator's Guide*.

## Step 5—Connect any external storage devices to the system unit.

If you are not connecting external storage devices at this time, turn to page 21 and continue with “Step 6—Set up the monitor.”

External storage devices for the DECstation 5000 Model 240 workstation are small computer systems interface (SCSI) drives (such as tape, disk, and compact disc drives) that are contained in external boxes you connect to the system unit. A SCSI drive can be self-contained in its own box or it can be in a multiple-drive expansion box, such as a BA42 expansion box or TURBOchannel extender.

1. Determine what external storage devices you have:
  - BA42 expansion box
  - TCE, if it has internal drives
  - Self-contained tape, disk, or compact disc drive (such as a TK50Z tape drive, TLZ04 cassette tape drive, or RRD42 compact disc drive)
2. Make sure the number of drives and number of expansion boxes to be connected are within allowable limits. You can connect up to seven drives, contained in up to three boxes, to the base system SCSI connector. (Additional storage devices can be connected to any SCSI connectors you may have in the TURBOchannel option slots.)
  - A self-contained drive contains one drive in its own box.
  - A BA42 expansion box can contain one or two drives. (See the *BA42 Installation Guide* if you need information on which drives can be installed in the BA42 expansion box.)
  - A TURBOchannel extender box can contain up to three drives. (See the *TURBOchannel Extender Operator's Guide* if you need information on which drives can be installed in the TURBOchannel extender.)

If you need to connect more than three expansion boxes to one SCSI connector, see Chapter 5 of the *DECstation 5000 Model 240 Hardware Operator's Guide* for instructions on how to ensure that the total SCSI cable length for the group of boxes is within the allowable limit of 236 inches.

**Caution:** Using more than 236 inches (6 meters) of SCSI cable on one SCSI connector makes the drives attached to that connector unreliable.

3. Check to make sure each drive has a unique SCSI ID within the group of devices you are connecting to one SCSI connector. If you don't know the specific SCSI ID for your device, assume it has the SCSI ID shown in Table 1.

The SCSI ID for a single drive in its own box is usually displayed in a small window on the back of the box. Table 1 lists the usual SCSI IDs assigned to drives preinstalled in single-drive, BA42, or TCE expansion boxes. The actual SCSI ID assigned to a drive may differ from the one listed here.

**Table 1. Usual SCSI ID Assignments for External Drives**

Type of External Drive	Usual SCSI ID
Hard disk drive	0
Hard disk drives in a multiple-drive expansion box	0 and 1
Diskette drive	4
Optical compact disc drive	4
Tape drive	5

If two or more of the drives to be connected to a SCSI connector have the same SCSI ID, you must change the duplicate SCSI IDs. Mark your place in this guide and refer to Chapter 5 of the *DECstation 5000 Model 240 Hardware Operator's Guide* for instructions on changing SCSI IDs.

4. Position the storage expansion boxes next to or on top of the system unit. If one of the boxes is a TURBOchannel extender, place it directly on top of the system unit, as one of its interconnecting cables is very short. You can stack the boxes one on top of the other.
5. Set the on/off switches on the storage expansion boxes to the off position.



Press the 0 on  
this type of switch.

WS3PI034

**Figure 10. On/off switch in the off position**

6. If the *only* device you are connecting is a TURBOchannel extender (TCE), skip the rest of this procedure, mark your place in this guide, and refer to the *TURBOchannel Extender Operator's Guide* for instructions on installing the TCE. When done, turn to page 21 and continue with "Step 6—Set up the monitor."  
Otherwise, continue with these instructions.



7. Find the system-unit-to-expansion-box cable that came with your workstation.

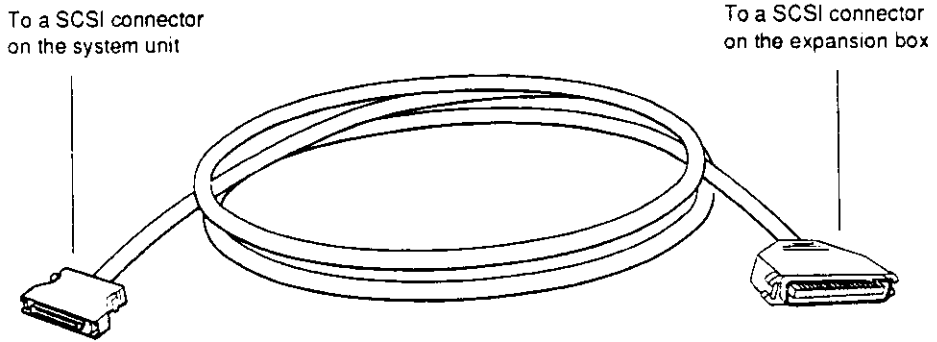

WS3PI035

**Figure 11. System-unit-to-expansion-box cable**

8. Attach the smaller connector on the system-unit-to-expansion-box cable to the SCSI connector on the system unit.

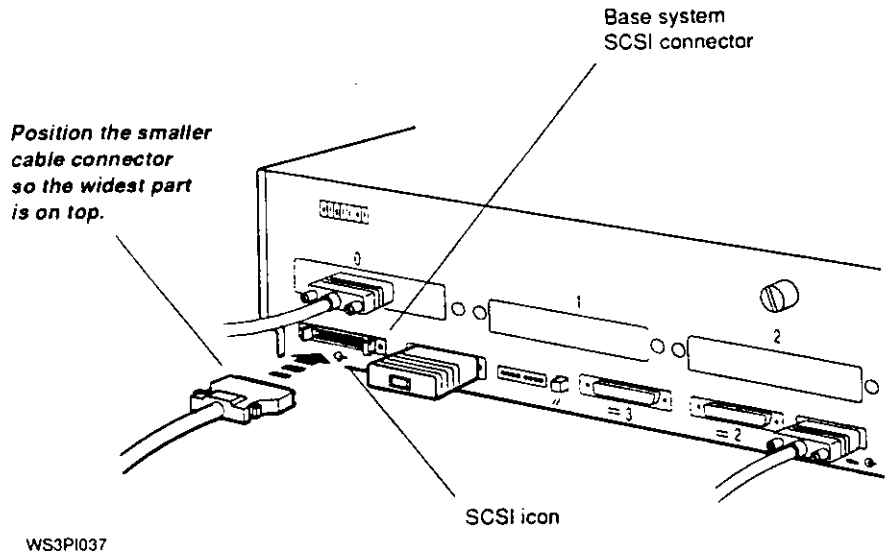

Figure 12. Attaching the smaller connector on the system-unit-to-expansion-box cable to the SCSI connector on the system unit

9. Attach the larger connector on the system-unit-to-expansion-box cable to either one of the SCSI connectors on the first non-TCE box closest to the system unit.

Do not connect this cable to a TCE, if you have one. Skip the TCE and connect the system-unit-to-expansion-box cable to the next box. (The TCE requires a different type of cable and must be connected last.)

1. Gently press the two wire brackets on the SCSI connector away from the connector.

2. Hold the cable connector so the widest part is on the top and push the cable connector into the SCSI connector as far as it will go.

3. Press the two wire brackets firmly against the sides of the cable connector until they lock into the grooves on the connector.

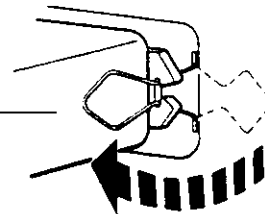
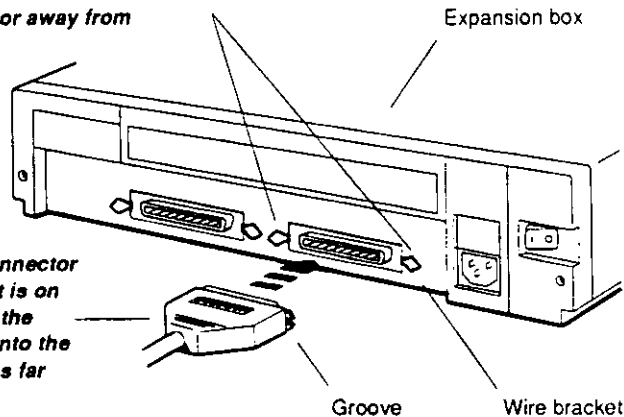

WS3PI038

Figure 13. Attaching the system-unit-to-expansion-box cable to the non-TCE box closest to the system unit

10. Connect any additional non-TCE expansion boxes to the first box using box-to-box SCSI cables.

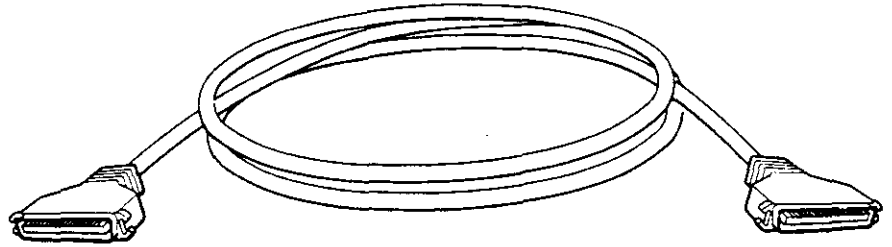

WS3PI054

**Figure 14. SCSI box-to-box cable**

Attach one end of the cable to the unused SCSI connector on the previously installed box. Connect the other end of the cable to a SCSI connector on the next box.

1. Gently press the two wire brackets on the SCSI connector away from the connector.

2. Hold the connector so the widest part of the connector is on top and push it into the SCSI connector on the expansion box.

3. Press the two wire brackets firmly against the side of the cable connector until they lock into the grooves on the sides of the connector.

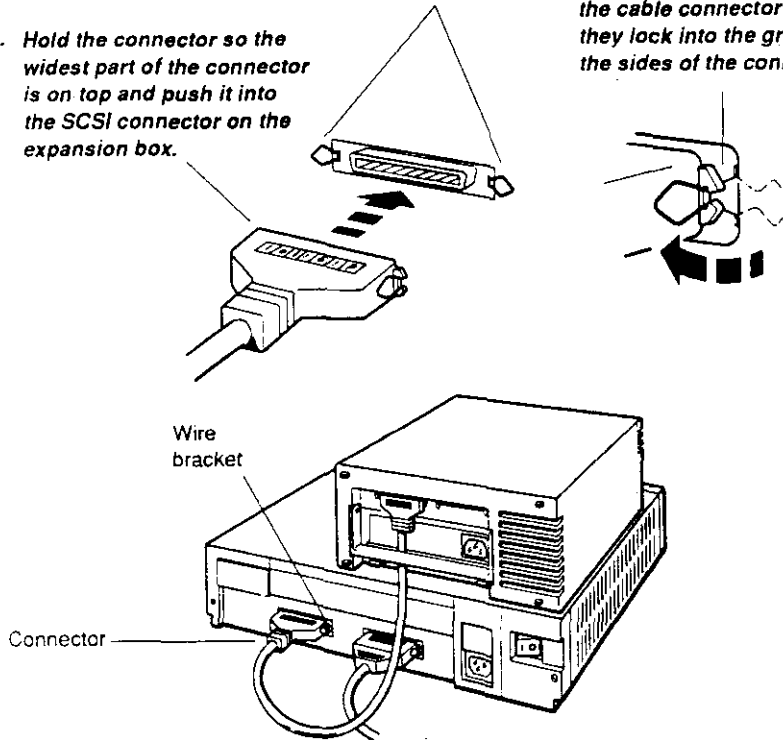

WS3PI002

Figure 15. Connecting additional non-TCE expansion boxes

11. If one of the storage devices is a TCE with internal drives, connect the TCE to the previous expansion box or self-contained drive.
  - a. Find the TCE-to-expansion box cable that came with the TCE (identical to the system-unit-to-expansion-box cable).

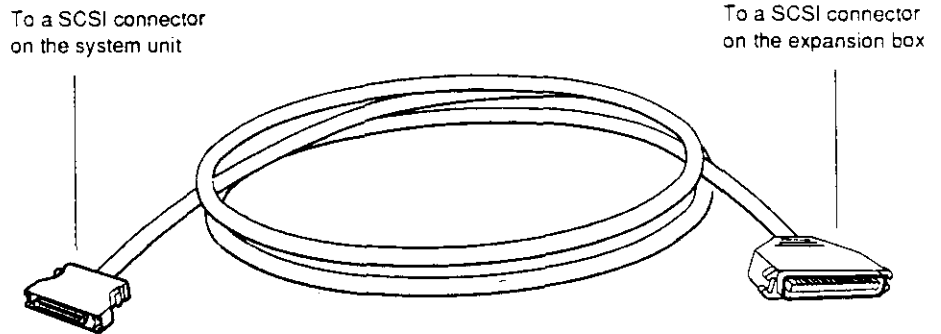

WS3P1091

Figure 16. TCE-to-expansion-box cable

- b. Connect the small metal end of the TCE-to-expansion-box cable to the SCSI connector on the TCE and connect the large end to the unused SCSI connector on the previous expansion box. The TCE must be the last box in the chain of storage devices.

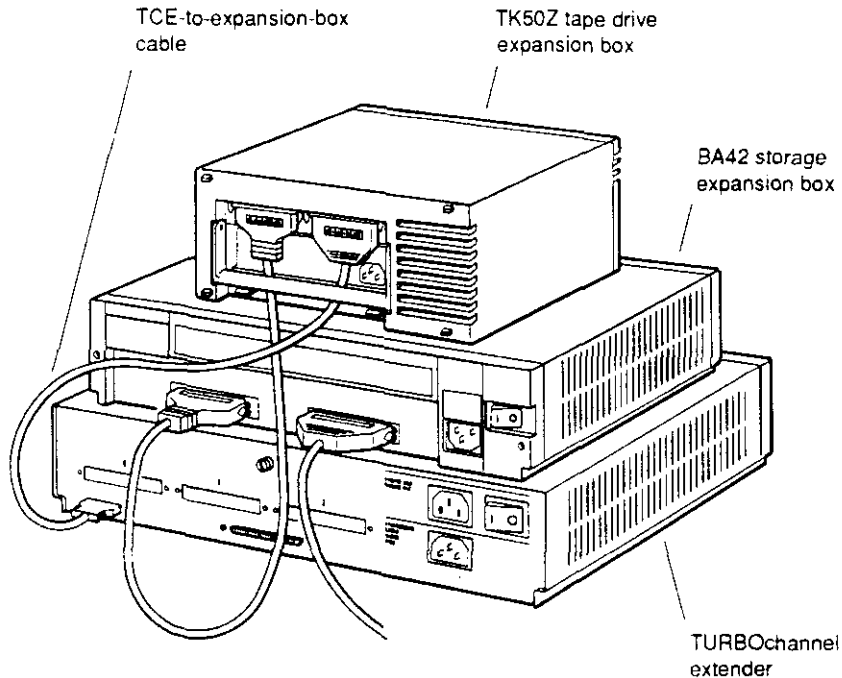

WS3PI093

**Figure 17. Connecting the TCE-to-expansion-box cable to the SCSI connector**

- Put a SCSI drive terminator on the unused SCSI connector on the last external storage device you connected, unless the last device you connected was a TCE, which has its own internal SCSI terminator.

*Hold the terminator so the widest part of its connector is on top and push the terminator onto the unused SCSI connector.*

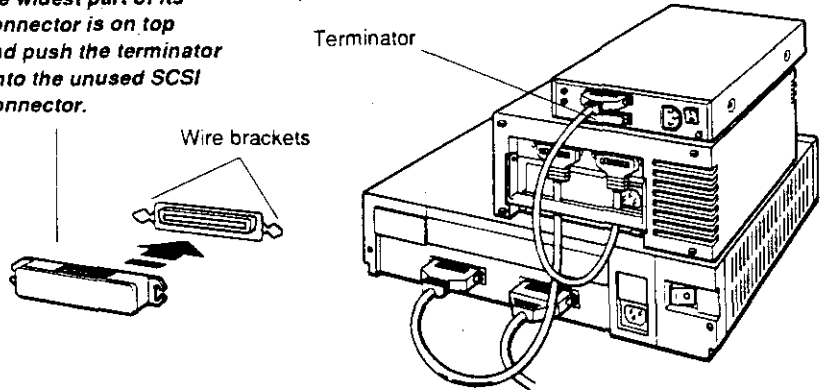

WS3PI003

**Figure 18. Attaching a SCSI drive terminator**



13. For each expansion box, connect one end of the power cord that came with the device to the expansion box and connect the other end to a power outlet.

**Caution:** Check the voltage requirements for the device. Connecting a device to a power source that does not meet the voltage requirements of that device can damage the device.

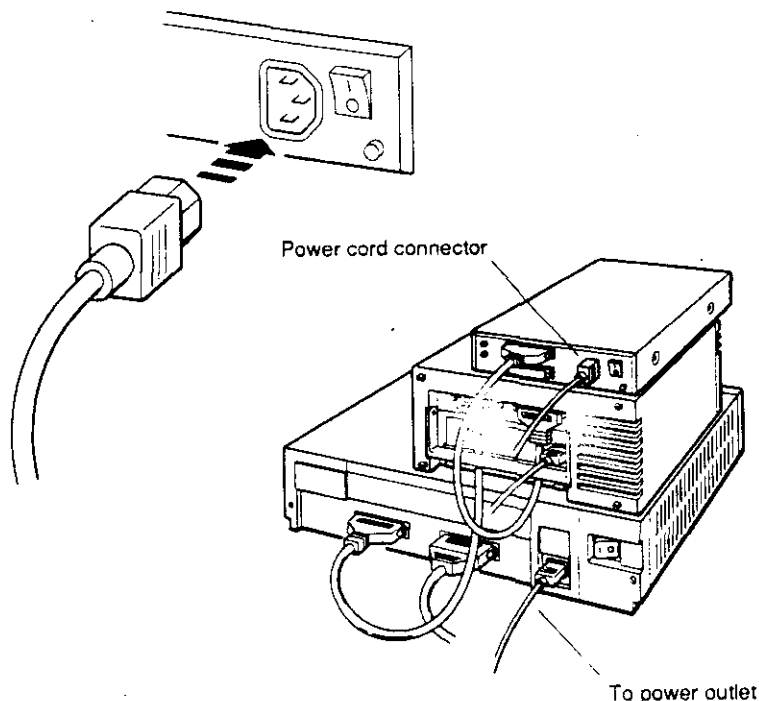

WS3PI042

**Figure 19. Connecting the power cords**

14. If you have additional SCSI connectors in the TURBOchannel option slots, repeat this procedure to connect any additional storage devices to these SCSI connectors.

Try to distribute the drives as evenly as possible among the SCSI connectors on the base system unit and in the TURBOchannel option slots.

## Step 6—Set up the monitor.

**Caution:** *It takes two people to unpack the monitor safely.*

1. Place the monitor on top of or beside the system unit, on top of the external storage devices, or wherever is convenient.

**Caution:** *Avoid placing the monitor near electromagnetic devices, such as printers or electric pencil sharpeners, or near iron or steel objects, such as filing cabinets or beams in walls, as this can interfere with its performance.*

2. Determine whether you have a color, gray scale, or monochrome monitor.
3. Locate the video connector to which you will attach your monitor. The video connector is on the system unit or TURBOchannel extender (TCE) unit. The examples used here assume that the video connector is in TURBOchannel option slot 0.

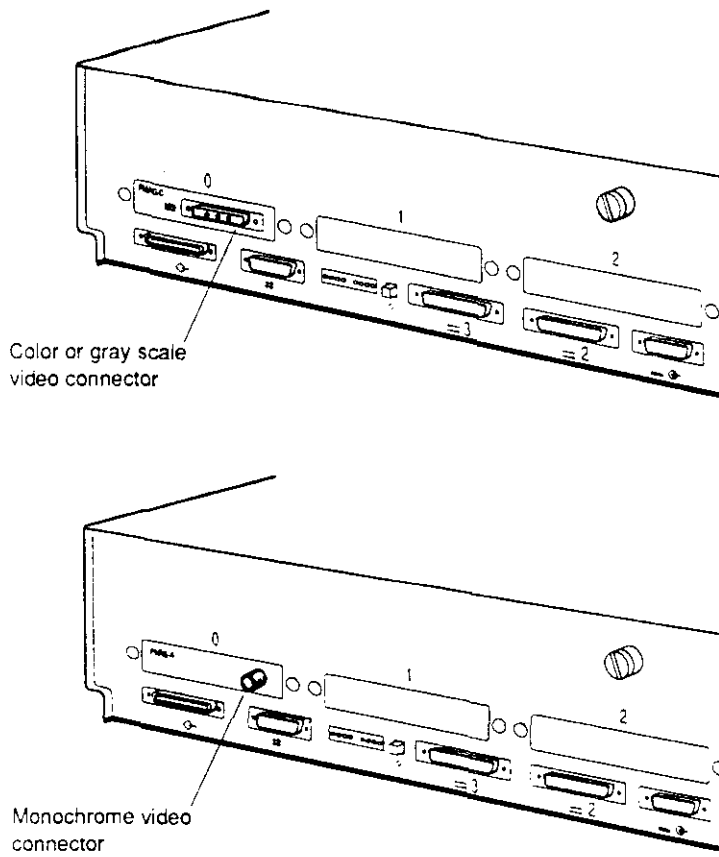

WS3P1092

**Figure 20. Video connectors**

4. If you are connecting more than one monitor to a workstation, locate all additional video connectors you will use. You can connect an additional monitor for each additional graphics option module in your workstation. Follow the instructions for connecting a single monitor to each one. (See the *DECstation 5000 Model 240 Hardware Operator's Guide* for more information on connecting multiple monitors.)
5. Be sure the on/off switches on the system unit and monitor are in the off position.

The monitor shown here is one of several different monitors you can order for your workstation. The exact type and position of the on/off switch will vary depending on the monitor you ordered.

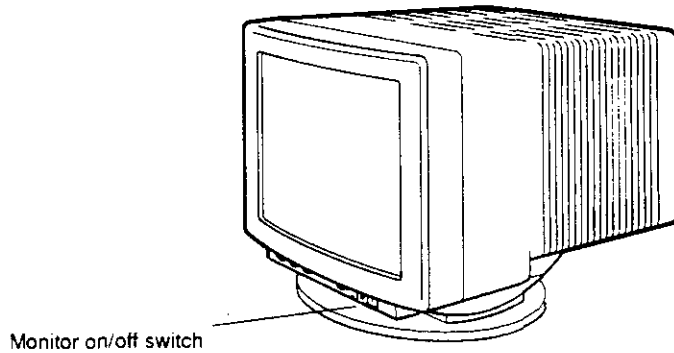

WS3PI090

**Figure 21. Monitor example**



Press the 0 on this type of switch.



Press and release this type of switch.



Press and release this type of switch until it is in the out position.

WS3PI008

**Figure 22. Monitor on/off switches**

## Step 7—Connect the monitor video cable.

The monitors shown in the following examples may differ in appearance from the monitor you have, but the instructions are accurate for all monitors of that general type.

To connect a color monitor video cable, continue with the instructions “To connect a color monitor video cable” on this page.

To connect a gray scale monitor video cable, turn to page 27.

to connect a monochrome monitor video cable, turn to page 30.

### To connect a color monitor video cable

1. Find the color video cable assembly that came with your shipment.

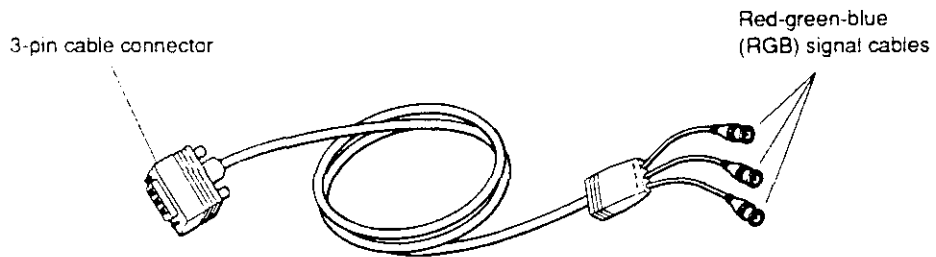

WS3PI010

Figure 23. Color video cable assembly

2. Connect the red, green, and blue signal cable connectors to the three round video connectors labeled R, G, and B on the monitor. The small collars on the cable connectors have two slots that fit over corresponding pins on the monitor connectors.

If your monitor has two sets of these connectors, use the bottom set, labeled VIDEO IN.

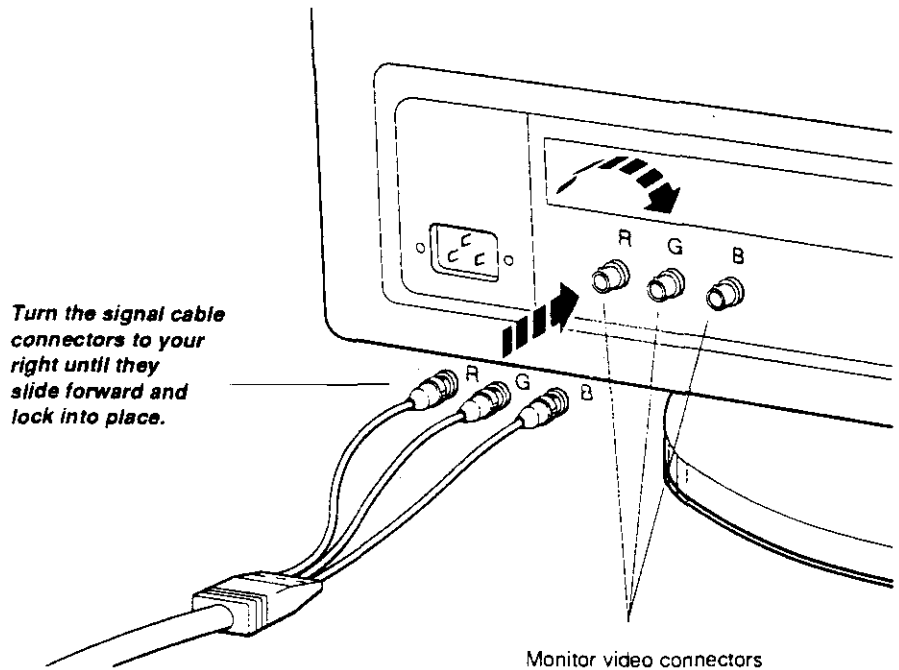

WS3PI011

Figure 24. Connecting a video cable assembly to a color monitor

3. Connect the 3-pin cable connector to the system unit video connector in the system unit or TCE box.

1. *Position the 3-pin cable connector so the widest part of the connector is on top.*

System unit video connector in TURBOchannel option slot 0

2. *Turn the screws to your right to hold the connector in place.*

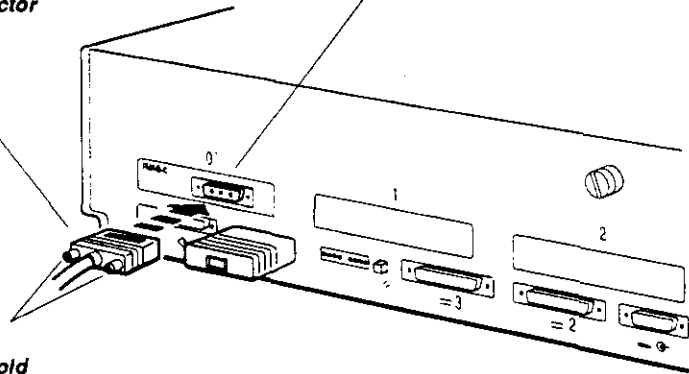

WS3PI015

Figure 25. Connecting a 3-pin cable connector to the system unit

4. Turn to page 33 and continue with "Step 8—Connect the monitor to a power source."

## To connect a gray scale monitor video cable

1. Find the gray scale cable assembly that came with your shipment.

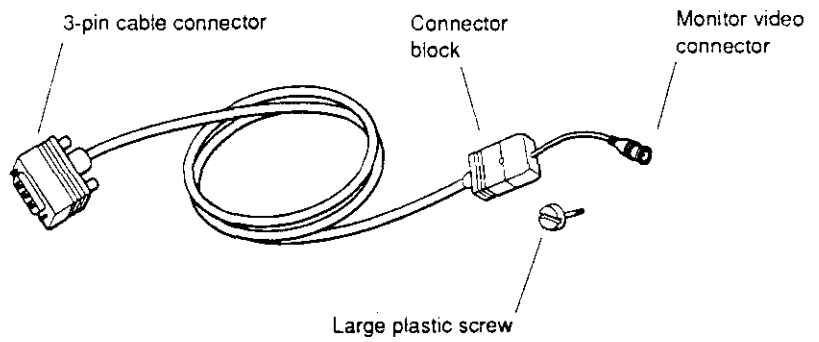

WS3PI013

Figure 26. Gray scale video cable assembly



2. Attach the round cable connector to the monitor.
3. Attach the connector block to the back of the monitor.

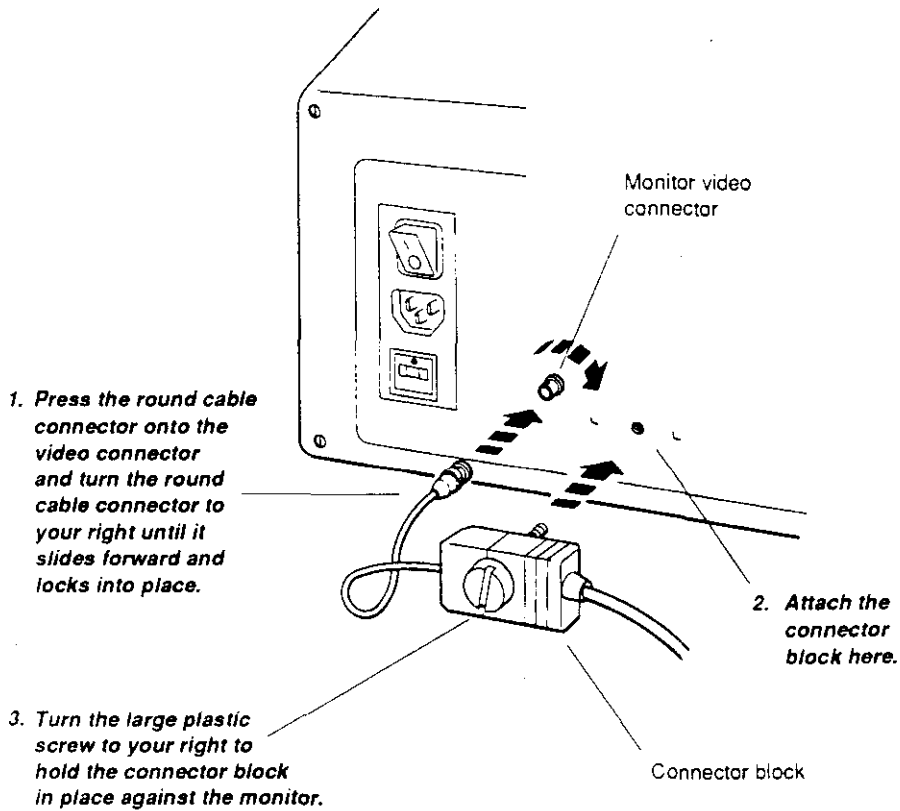

WS3PI014

Figure 27. Connecting a video cable assembly to a gray scale monitor

4. Attach the 3-pin cable connector to the workstation video connector in the system unit or TCE box.

1. *Position the 3-pin cable connector so the widest part of the connector is on top.*

System unit video connector in TURBOchannel option slot 0

2. *Turn the screws to your right to hold the connector in place.*

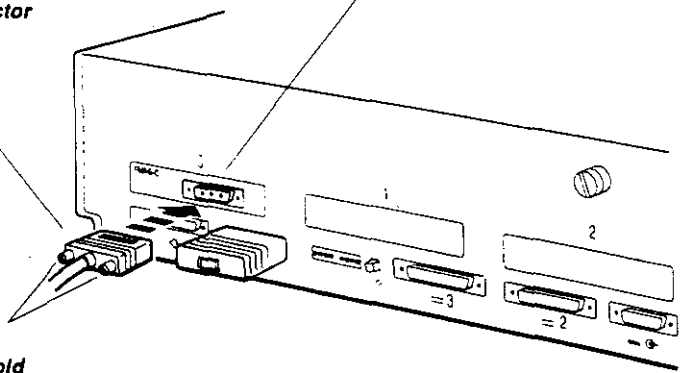

WS3PI015

**Figure 28. Connecting a gray scale video cable assembly to the system unit**

5. Turn to page 33 and continue with "Step 8—Connect the monitor to a power source."

## To connect a monochrome monitor video cable

1. Find the monochrome video cable assembly that came with your shipment.

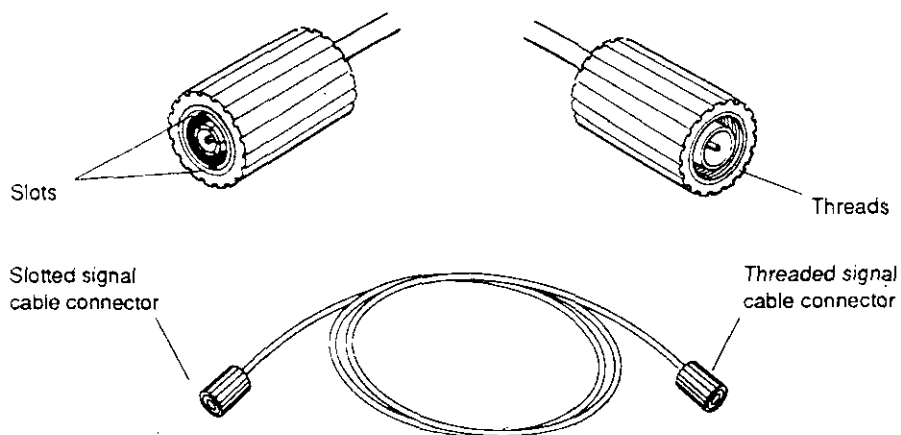

WS3PI016

Figure 29. Monochrome video cable assembly

2. Attach the slotted cable connector to the monitor video connector.

1. *Align the slots on the cable connector with the pins on the monitor video connector.*

2. *Press the slotted cable connector onto the monitor connector and turn the slotted cable connector to your right until it slides forward and locks into place.*

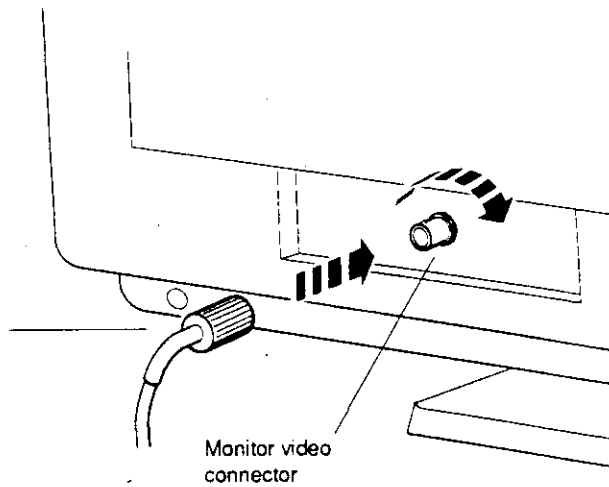

WS3PI018

**Figure 30. Connecting a video cable assembly to a monochrome monitor**

3. Attach the threaded cable connector to the video connector in the system unit or TCE box.

*Press the threaded cable connector onto the video connector and turn the threaded connector to your right as far as it will go.*

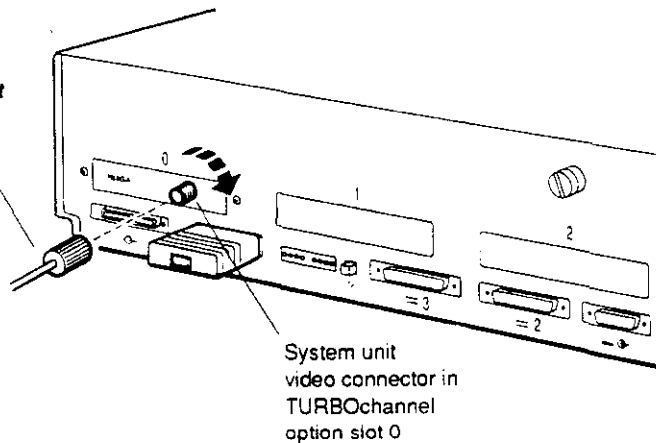

WS3PI017

**Figure 31. Connecting a monochrome video cable assembly to the system unit**

4. Turn to page 33 and continue with "Step 8—Connect the monitor to a power source."

## Step 8—Connect the monitor to a power source.

1. Find the monitor-to-system-unit power cable or the monitor power cord (identical to the system unit power cord) that came with your workstation.

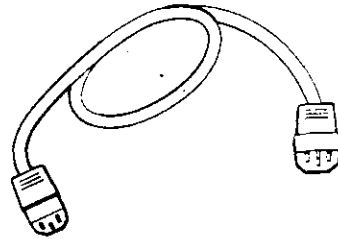

**Monitor-to-system-unit  
power cable**

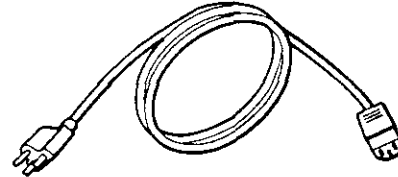

**Monitor power cord**

WS3P1058

**Figure 32. Monitor-to-system-unit power cable and monitor power cord**

2. Check the monitor voltage requirement labels printed on the monitor (or check for a yellow voltage label covering its power connector).

***Caution:** Connecting a device to a power source that does not meet the voltage requirements of that device can damage the device.*

3. If the monitor is too far from the system unit for the monitor-to-system-unit power cable to reach, connect the monitor directly to a power outlet or power strip with the monitor power cord.

Otherwise, plug the appropriate end of the monitor-to-system-unit power cable into the power connector on the monitor. Plug the other end into the monitor-to-system-unit power connector on the system unit.

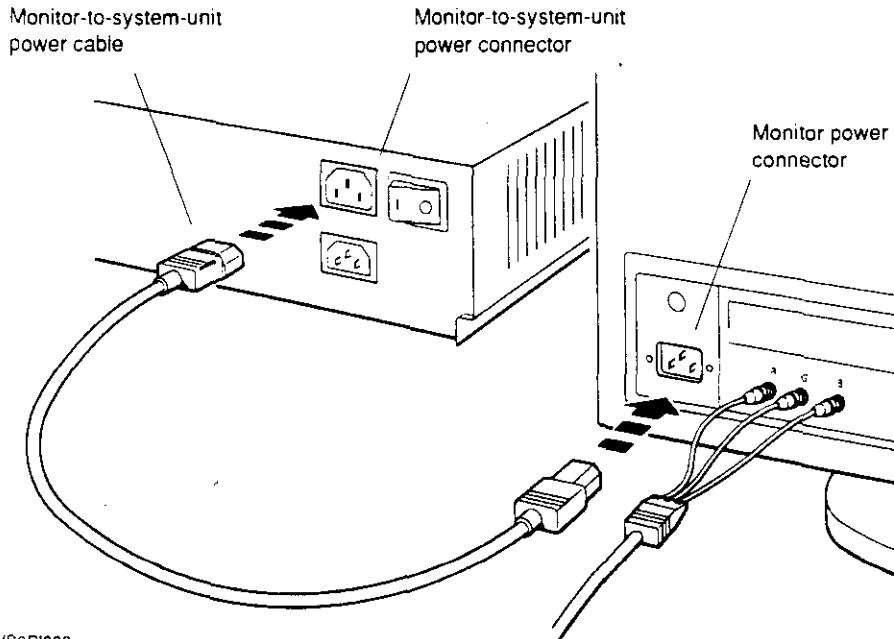

WS3PI033

**Figure 33. Connecting the monitor-to-system-unit power cable**

4. If you connected your monitor to the power outlet on the system unit, set the monitor power switch to the on position.



Press the | on this type of switch.



Press and release this type of switch.



Press this type of switch in.

WS3PO057

**Figure 34. Turning on the monitor**

## Step 9—Connect the keyboard and the mouse or tablet to the system unit.

1. Find the keyboard-mouse cable assembly that came with your workstation.

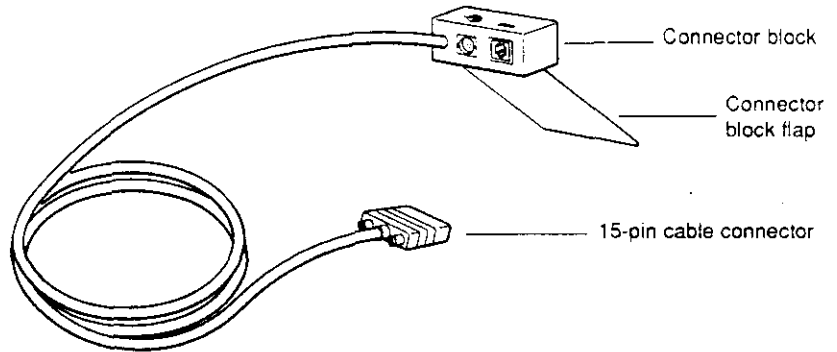

WS3PI068

Figure 35. Keyboard-mouse cable assembly



2. Plug the 15-pin connector on the keyboard-mouse cable assembly into the keyboard-mouse connector on the system unit.

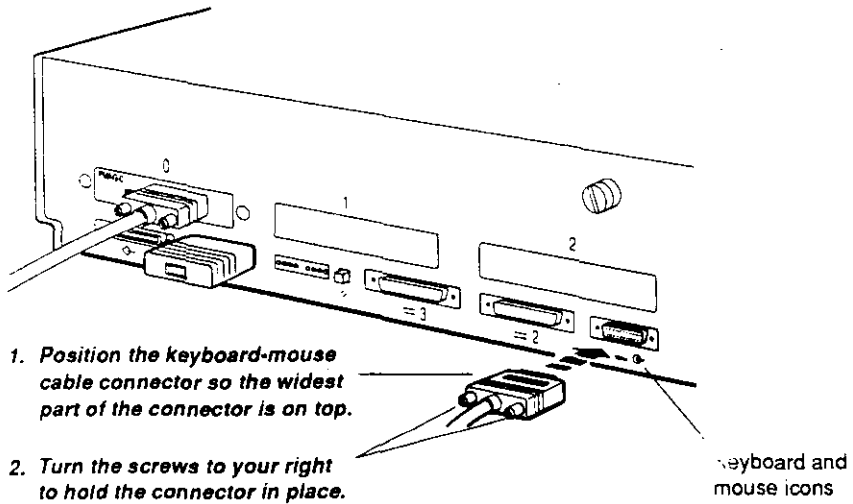

WS3PI020

Figure 36. Connecting the keyboard-mouse cable assembly to the system unit

3. Insert the mouse or tablet cable connector and the keyboard cable connector into the connector block of the keyboard-mouse cable assembly.

1. *Position the mouse or tablet cable connector so the icon on it is below the mouse icon on the connector block. Then push the connector into the connector block.*

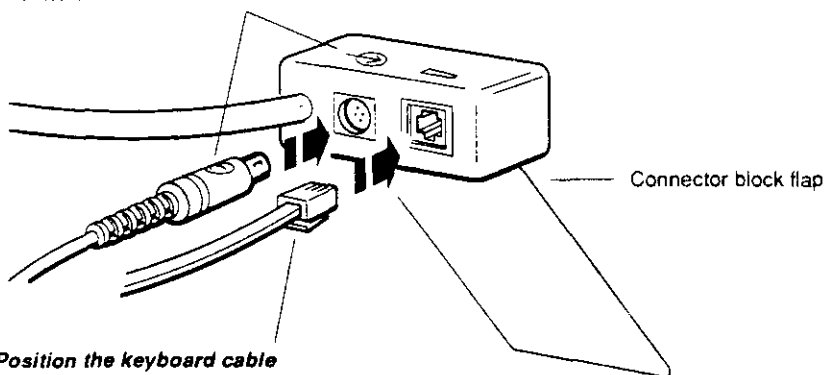

2. *Position the keyboard cable connector so the clip is on the bottom and push the connector into the connector block until it clicks into place.*

WS3PI019

Figure 37. Connecting the keyboard cable to the connector block

4. Lift the back of the monitor slightly, slide the plastic flap on the connector block under the base of the monitor, and lower the base onto the flap.

Be sure that the entire flap is under the base.

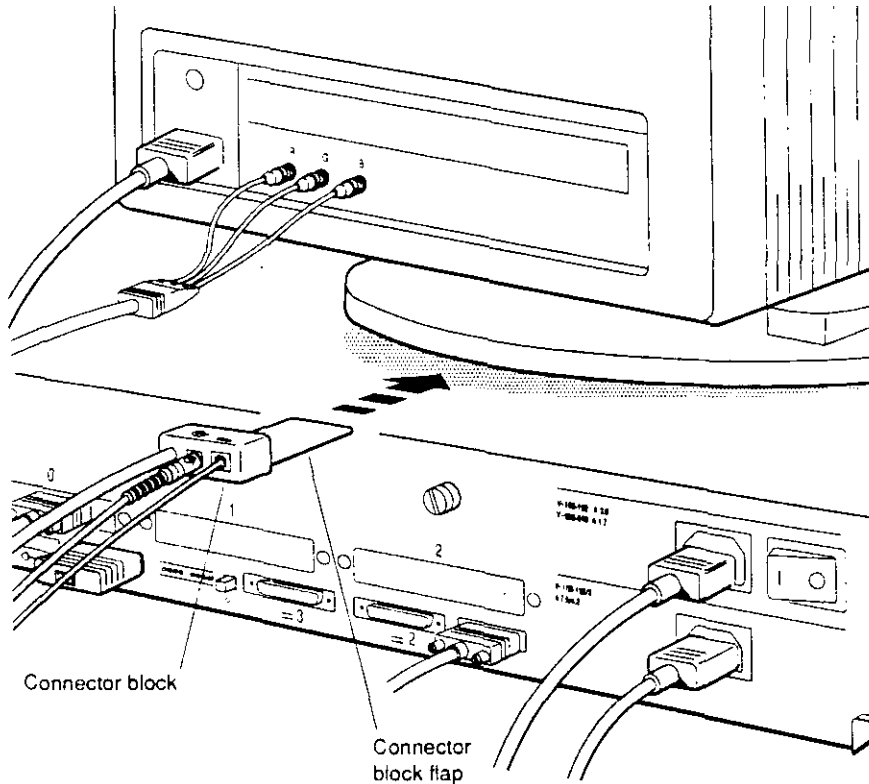

WS3PI047

**Figure 38. Positioning the connector block**

## **Step 10—Connect any communication devices to the system unit.**

If you have optional communication devices such as modems or printers, mark your place in this guide and refer to Chapter 7 of the *DECstation 5000 Model 240 Hardware Operator's Guide* for installation instructions.

If you have no optional communication devices to install, continue with "Step 11—Turn on and test the workstation."

## **Step 11—Turn on and test the workstation.**

Before turning on your workstation for the first time,

- Plug the system unit power cord into a wall outlet or power strip.
- Make sure the monitor and any external devices are plugged into a power source.
- If any part of your workstation is plugged into a power strip, make sure the power strip is plugged into a power outlet.
- If you intend to control power to your workstation by turning the power strip on and off, make sure all power switches on the workstation components are set to the on position.

If all parts of your workstation are plugged into a power strip, turn on the power strip to turn on your workstation.

Otherwise, turn on your workstation in the order described here:

1. Turn on any external devices. Most devices have rocker switches. Some have push switches.
2. If necessary, turn on the monitor.
  - If the monitor gets its power through the system unit, and if you have set the monitor power switch to the on position, it will go on when you turn on the system unit.

- If the monitor is plugged into a wall outlet, or if the monitor power switch is in the off position, turn it on now (for instructions, refer to the documentation that came with the monitor).

When the monitor is receiving power, a green indicator light glows on the front of the monitor. The monitor must run for 10 to 15 seconds before it is warmed up enough for the display to be visible.

3. Turn on the system unit by pressing the 1 on the on/off switch on the back of the system unit.

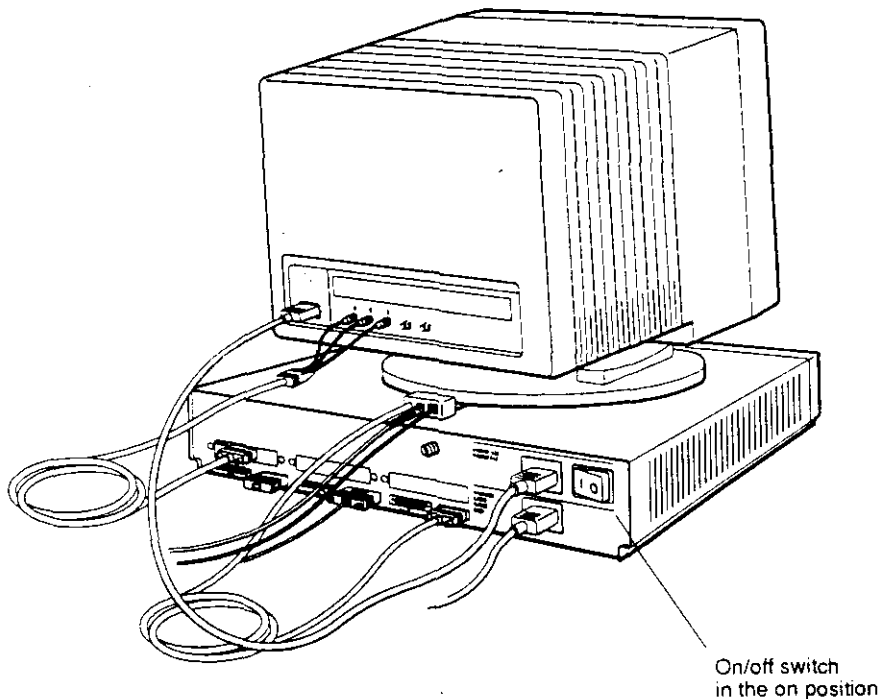

WS3P1096

**Figure 39.** Turning on the system unit

4. When you turn on the system unit, the following things happen:

- The green power indicator light glows on the front of the system unit.
- The system unit runs the automatic power-up self-test, which takes from 1 to 5 minutes. It displays the names of each subtest that it runs at the bottom of the screen. Some tests display asterisks (\*) and other symbols, and some tests cause the screen to flicker.

If you have multiple monitors connected to your workstation, the monitor connected to the graphics module in the lowest-numbered option slot will display all system test information.

At the end of the power-up self-test, messages explaining any errors that occurred during any of the subtests scroll across the screen. (You can redisplay these messages later.)

5. If you are installing the workstation for the first time, you will be prompted to select the keyboard language. The screen displays the following language menu:

1) Dansk	9) Français (Suisse Romande)
2) Deutsch	10) Italiano
3) Deutsch (Schweiz)	11) Nederlands
4) English (American)	12) Norsk
5) English (British/Irish)	13) Português
6) Español	14) Suomi
7) Français	15) Svenska
8) Français (Canadien)	16) Vlaams

(1..16): \_

Type the number that corresponds to your language and press Return. The console prompt (>>) appears on the screen when the language is set.

If you need to change the workstation language, type **setenv console 0** at the console prompt and press Return. The language menu will be redisplayed. Select a language and press Return.

6. The screen displays the console prompt (>>) or the restricted console prompt (R>) when the system is ready to accept user commands.

- Users can execute all console commands at the console prompt (>>).
- The restricted console prompt (R>) indicates that someone has set up a password requirement to restrict access to the system. At the restricted console prompt, you can use only the boot and passwd console commands until you enter the correct password.

To enter your password, type **passwd** and press Return. Then enter the console password at the `pwd` prompt and press Return again. If you don't know the password, contact your system manager or a Digital service representative.

If anything other than the console prompt (>>), or restricted prompt (R>) appears, refer to Chapter 11 of the *DECstation 5000 Model 240 Hardware Operator's Guide* for troubleshooting instructions.

7. At the console prompt, type **erl** and press Return to display a complete list of any error messages that scrolled across the screen during the self-test.

If you see any error messages, or if you see a message that begins with `?TFL:`, refer to Chapter 11 of the *DECstation 5000 Model 240 Hardware Operator's Guide* for troubleshooting instructions. After correcting the error, turn the system unit off and then turn it back on again.

8. If your system unit fails to turn on, turn it off and check to be sure that

- Power cords are connected properly and the power strip, if there is one, is plugged in and turned on.
- There is power at all power outlets.
- All power switches are set to the on position.

If the system unit still fails to work, refer to Chapter 11 of the *DECstation 5000 Model 240 Hardware Operator's Guide* for troubleshooting instructions.

## Step 12—Check to see if your workstation recognizes all internal option modules.

1. At the console prompt, type **cnfg** and press Return to see if your workstation lists all of the memory and the TURBOchannel option modules that you installed (or that were pre-installed) in your workstation.

A display similar to the following sample appears on your screen:

```
>>cnfg
3:  KN03-AA   DEC      X2.0d   TCF0   (224 MB,   1 MB NVRAM)
      (enet: 08-00-2b-0f-45-72)
      (SCSI = 7)
0:  PMAG-DA   DEC      V5.3d   TCF0   (DA:PXG+ - D=8 z=24)
1:  PMAD-AA   DEC      V5.3d   TCF0   (enet: 08-00-2b-0f-45-31)
```

2. Find the 3: and the 0: in the leftmost column of the sample display. These numbers identify the base system or TURBOchannel option slots for which information is being provided. The display shows only the base system slot (slot 3) and any TURBOchannel option slots that contain option modules. In this example, slots 0 and 1 contain option modules.
3. Check to see if the amount of memory displayed is correct. Look at the entry in parentheses at the end of the line starting with 3:. The first entry tells you how much memory you have (in this example, 224 megabytes). The second entry in the parentheses tells you how much battery backed-up memory you have (in this example, 1 megabyte). Battery backed-up memory is optional. If the amount of memory differs from the amount ordered for or installed in your workstation, refer to Chapter 11 of the *DECstation 5000 Model 240 Hardware Operator's Guide* for troubleshooting instructions.
4. Make sure any TURBOchannel option modules that should have been installed are listed in the display.



Look at the lines that begin with 0: and 1: in the sample display. These lines describe the modules installed in TURBOchannel option slots 0 and 1 in this example. To find out what kind of TURBOchannel option module is present in a TURBOchannel option slot, look at the entry in the parentheses on the line beginning with that slot number. Then compare it with the entries in Table 2. For example, the option module DA:PXG+ installed in option slot 0 is a low 3D graphics accelerator, according to the table.

If the modules that should have been installed in the system unit do not appear in the configuration display, turn to Chapter 11 of the *DECstation 5000 Model 240 Hardware Operator's Guide* for troubleshooting instructions. (If you have a TURBOchannel module installed in a TCE, it will be listed as installed in the system unit slot to which the TCE is connected. That slot actually contains the TCE option module connected to the TURBOchannel module in the TCE, but only the TURBOchannel module in the TCE will appear in the display.)

**Table 2. Base System and TURBOchannel Option Module Codes**

CX---d=8 or 24	True color frame buffer, where d=8 indicates color or gray scale and d=24 indicates "true" color (any color the eye can see). This module can be installed in any TURBOchannel option slot.
CXT 8 plane	Smart frame buffer. This module can be installed in any TURBOchannel option slot.
DA: PXG+---D=8 or 24	Low 3D graphics accelerator, where D=8 indicates color or gray scale and D=24 indicates "true" color (any color the eye can see). This module occupies two adjacent TURBOchannel option slots, but is connected to the system through the lower-numbered slot.

(continued on next page)

**Table 2 (Cont.). Base System and TURBOchannel Option Module Codes**

---

EA: PXG+---D=8 or 24	Mid 3D graphics accelerator, where D=8 indicates color or gray scale and D=24 indicates "true" color (any color the eye can see). This module occupies two adjacent TURBOchannel option slots, but is connected to the system through the lower-numbered slot.
enet:	Ethernet controller. A ThickWire Ethernet controller is built into the base system. Other Ethernet controllers may be installed in the TURBOchannel option slots. The long number after enet: is a unique Ethernet station address that identifies the controller for the network software.
FA: PXGTurbo+	High 3D graphics accelerator. This module occupies three adjacent TURBOchannel option slots, but is connected to the system through the lower-numbered slot.
MB	Memory module. The number indicates the megabytes of memory installed in base slot 3.
MX---D=1	Monochrome frame buffer, where D=1 indicates black and white. This module can be installed in any TURBOchannel option slot.
NVRAM	Nonvolatile random access memory module. An NVRAM module is an optional module that is preinstalled in the base system, if purchased for your workstation. It provides 1 megabyte of battery backed-up memory that will retain data during power failures.
PX---D=8	2D graphics accelerator, where D=8 indicates color or gray scale. This module can be installed in any TURBOchannel option slot.
SCSI	SCSI controller. One is built into base slot 3; others may be installed in the TURBOchannel option slots.

---

## Step 13—Find and report your Ethernet station address.

If your workstation will *not* be connected to an Ethernet network, skip this step and continue with “Step 14—Check to see if your workstation recognizes all external storage devices.”

Every Ethernet connector has a built-in controller. That controller has a unique ID called an Ethernet station address. The system manager needs the Ethernet address (or addresses) for your workstation in order to connect your workstation to the network for you. You need to find and report the Ethernet station address for each Ethernet controller on your workstation.

1. In the `cnfg` display, look for any entries within parentheses that start with `enet:`. The entry after `enet:` is the Ethernet station address.

```
>>cnfg
3:  KN03-AA    DEC      X2.0d    TCF0    (224 MB,    1 MB NVRAM)
                                     (enet: 08-00-2b-0f-45-72)
                                     (SCSI = 7)
0:  PMAG-DA    DEC      V5.3d    TCF0    (DA:PXG+ - D=8 z=24)
1:  PMAD-AA    DEC      V5.3d    TCF0    (enet: 08-00-2b-0f-45-31)
>>
```

In this display, both lines 3: and 1: show Ethernet station addresses:

- ① The Ethernet address for the Ethernet controller in base slot 3 is 08-00-2b-0f-45-72.
  - ② The Ethernet address for the Ethernet controller in option slot 1 is 08-00-2b-0f-45-31.
2. Write down the Ethernet address for each Ethernet controller to be connected to a network. Report the addresses to your system manager and ask the manager to complete the Ethernet connections for you.

## Step 14—Check to see if your workstation recognizes all external storage devices.

1. Type **cnfg 3** at the console prompt (>>) and press Return to check the slot configuration for the base system (slot 3).

The following is a sample slot configuration display for the base system:

```
>>cnfg 3
3: KN03-AA DEC X2.0d TCF0 (224 MB, 1 MB NVRAM)
(enet: 08-00-2b-0f-45-72)
(SCSI = 7)
-----
DEV PID VID REV SCSI DEV
-----
rz0 RZ55 (C) DEC DEC 0700 DIR
rz1 RZ24 (C) DEC DEC 0700 DIR
rz4 RRD42 (C) DEC DEC 0700 CD-ROM
tz5 SEQ
dcache( 64 KB), icache( 64KB)
mem( 0): a0000000: a1fffffff ( 32 MB)
mem( 1): a2000000: a3fffffff ( 32 MB)
mem( 2): a4000000: a5fffffff ( 32 MB)
mem( 3): a6000000: a7fffffff ( 32 MB)
mem( 4): a8000000: a9fffffff ( 32 MB)
mem( 5): aa000000: abfffffff ( 32 MB)
mem( 6): ac000000: adfffffff ( 32 MB)
mem(14): bc000000: bc0ffffff ( 1 MB) Presto-NVR
mem(14): clean, batt OK, armed
>>
```

2. Check the slot configuration display to see if the system recognizes all of the drives in the external storage devices you connected to the SCSI connector in that slot.
  - a. Look in the column labeled **SCSI DEV** for a coded description of the type of drive (in this example, DIR, CD-ROM, and SEQ).
  - b. Look in the column labeled **PID** for a coded description of the part ID number (in this example, RZ55, RZ24, and RRD42).
  - c. Look in the column labeled **DEV** for the device code and SCSI ID for each of the drives connected to the base system SCSI connector (in this example, rz0, rz1, rz4, and tz5). The last character of the code is the SCSI ID. The drives in this example have the SCSI IDs 0, 1, 4, and 5.

Table 3 lists the device codes, device descriptions, and types of drives you may see in your slot configuration display.

**Table 3. Device Codes for Different Types of SCSI Drives**

Device Code (DEV)	Device Description (SCSI DEV)	Type of Drive
rx	DIR	Diskette
rz	CD-ROM	Optical compact disc
rz	DIR	Hard disk
tz	SEQ	Tape

- d. The slot configuration display should show a separate SCSI ID for every external drive you connected to the SCSI connector in that slot. If a drive is not listed, turn to Chapter 11 of the *DECstation 5000 Model 240 Hardware Operator's Guide* for troubleshooting instructions.
3. If you have any external storage devices attached to a SCSI connector in a TURBOchannel option slot, type **cnfg slot-number**, replacing *slot-number* with the number of the option slot (0, 1, or 2) you want to check.

Then check for the presence of all drives connected to that slot, as described in the previous step.

## Step 15—Install the worksystem software.

You need the following ULTRIX manuals to install the worksystem software:

- *Guide to Installing ULTRIX*
- ULTRIX release notes

## To install the worksystem software from a network

1. Make sure that you reported your Ethernet address to your system manager and that your workstation has been connected to the Ethernet network.
2. Ask your system manager to install the worksystem software for you.

## To install the worksystem software from a tape drive

1. Remove the ULTRIX software installation tape cartridge from your ULTRIX tape cartridge kit (refer to the *Guide to Installing ULTRIX* for the full name of the installation tape). Make sure the tape is write-protected.

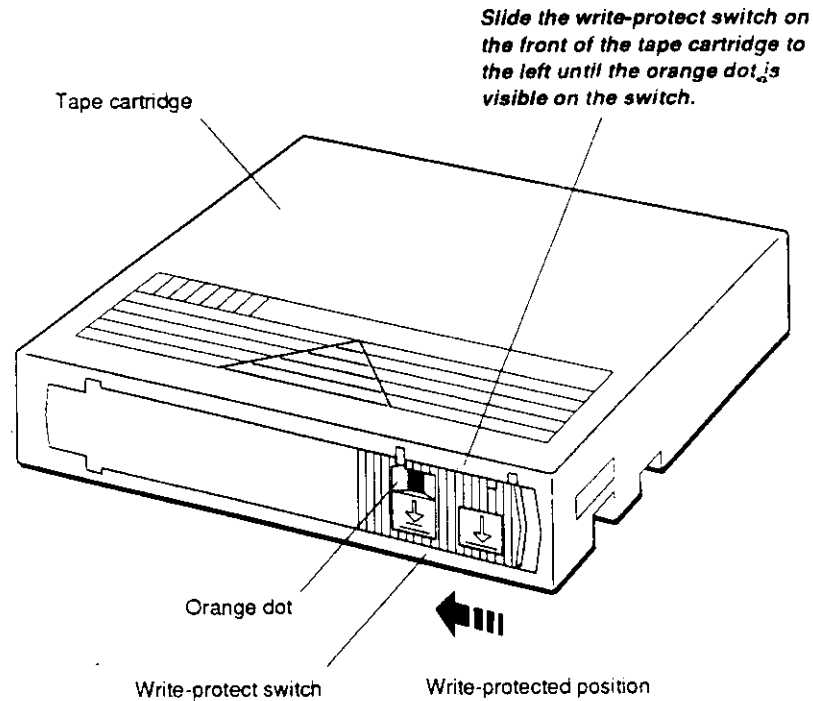

WS3PI048

Figure 40. ULTRIX software installation tape cartridge

2. Open the door to the tape drive.

*Insert three fingers behind the lip on the left side of the top of the drive door and pull the door away from the drive to open it.*

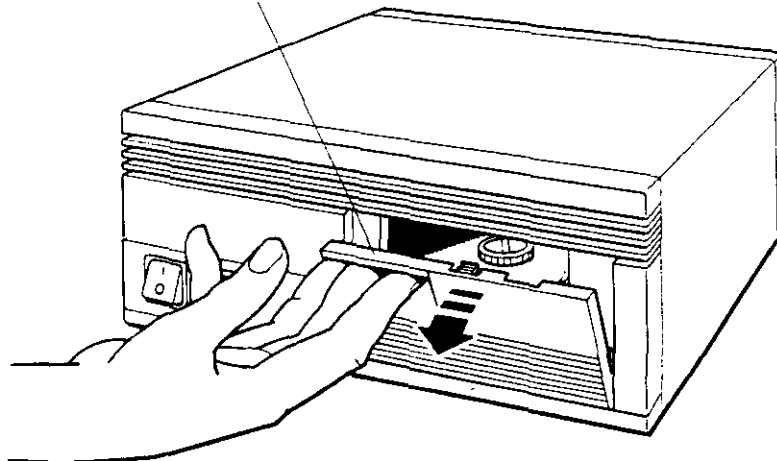

WS3PI049

Figure 41. Opening the door to the tape drive

3. Make sure the load/unload button on the tape drive is in the unload (out) position. Then turn on the power by pressing the power button. Wait for the drive self-test to run.

The red indicator light shines steadily for 5 to 15 seconds while an internal self-test runs. Then the red indicator light goes off and the green indicator light comes on. If at any time the red light flashes rapidly, there is a problem with the tape drive. See the troubleshooting section of the tape drive owner's manual for help or contact your field service representative.

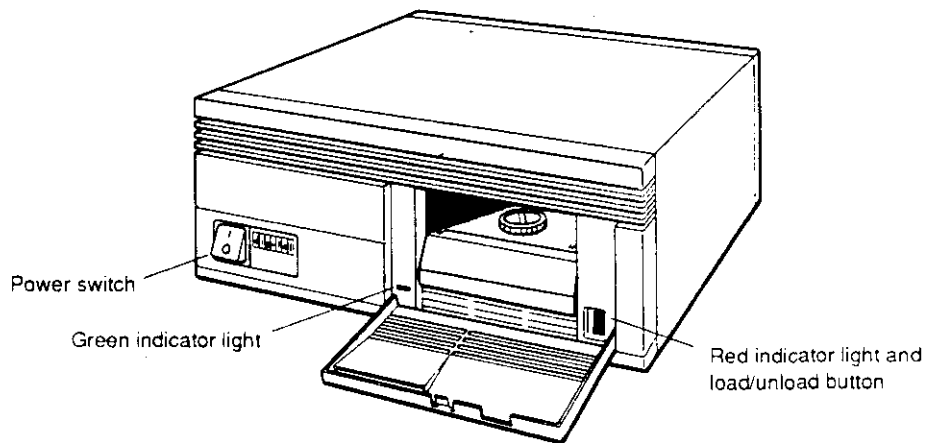
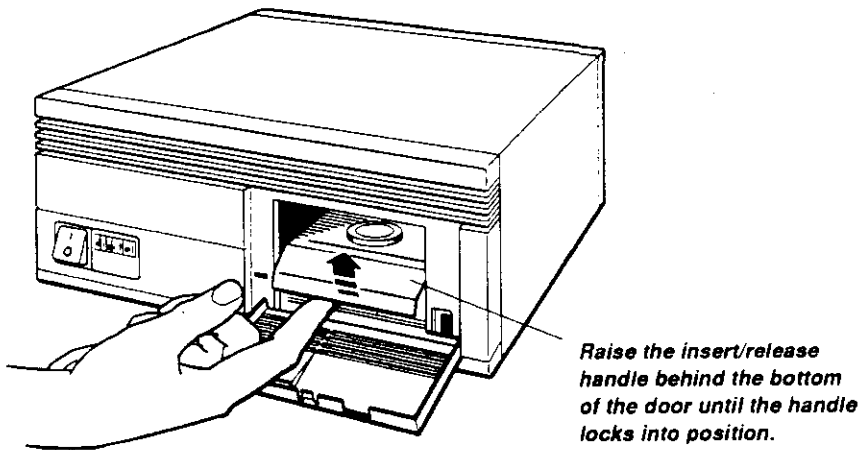

**Figure 42.** Power switch and indicator lights on tape drive



4. Lift the cartridge insert/release handle.

*Caution: Never lift the handle when the green light is off or blinking, as this may cause an error or damage the drive.*



WS3PI051

Figure 43. Lifting the cartridge insert/release handle

5. With the arrow on the tape cartridge pointing away from you, load the tape cartridge into the drive. (The owner's manual for the drive explains how to insert and remove tapes.)

**Caution:** *You will feel some resistance as you push the cartridge into place. It is very important not to stop at this point, but to continue pushing the cartridge firmly until it locks into place.*

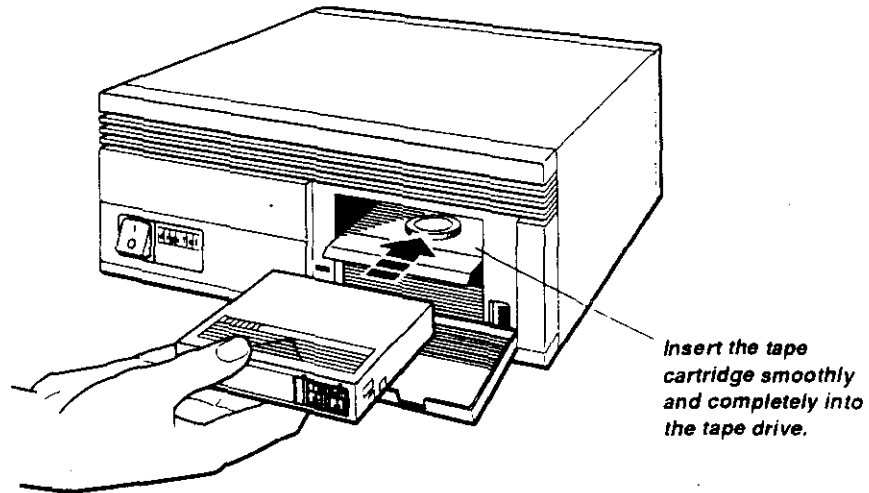

WS3Pi056

Figure 44. Inserting the tape cartridge

6. When the red indicator light turns on and the green indicator light goes off, lower the cartridge insert/release handle to the locked (closed) position.

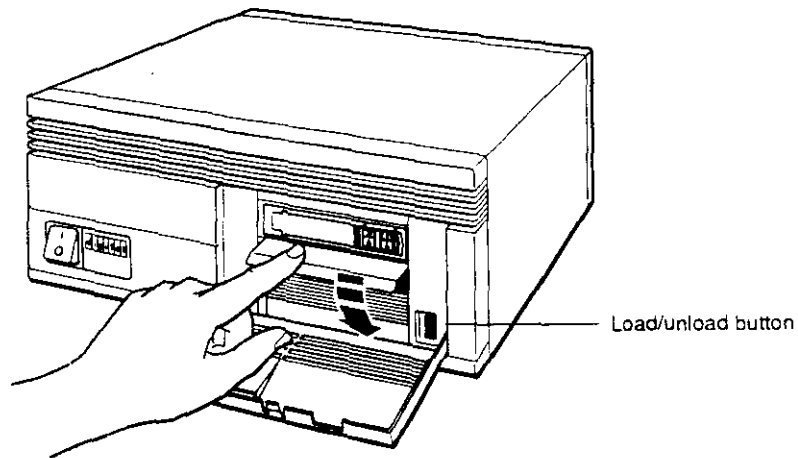

WS3PI004

Figure 45. Lowering the cartridge insert/release handle

After several seconds, the green indicator light glows steadily and the red indicator light turns off.

7. Press the load/unload button so it is in the load (in) position.

The tape goes through a load process that takes 5 to 7 seconds. Both lights come on and glow steadily when the tape reaches its beginning and is ready for use.

8. Find the device code and SCSI ID for the tape drive you are using.

At the console prompt (>>), type **cnfg slot-number**, replacing *slot-number* with the number of the slot in which the tape drive is installed (0, 1, 2, or 3). For example, if the tape drive is attached to the base system SCSI connector, type **cnfg 3**. Then press Return.

Here is the relevant portion of a sample display:

```
>>cnfg 3
3:  KN03-AA   DEC   X2.0d   TCF0   (224 MB,   1 MB NVRAM)
                                     (enet: 08-00-2b-0f-45-72)
                                     (SCSI = 7)
```

DEV	PID		VID	REV	SCSI DEV
rz0	RZ55	(C) DEC	DEC	0700	DIR
rz2	RZ24	(C) DEC	DEC	0700	DIR
rz4	RRD42	(C) DEC	DEC	0700	CD-ROM
tz5					SEQ

All device codes in this display appear in the column labeled DEV. The device code for all tape drives begin with tz. In the example, the device code for the tape drive is tz5.

9. Type **boot slot-number/device-code**. Replace *slot-number* with the tape drive's slot number (0, 1, 2, or 3) and *device-code* with the device code of the tape drive. Then press Return. For the drive in the example, you would type **boot 3/tz5**.

If the message ?IO: 3/tz5 (bb rd) appears on the screen, make sure that the proper tape cartridge is in the drive and the red and green lights are glowing steadily. If retyping the boot command still causes this message to appear, contact your Digital service representative.

10. Follow the instructions on your screen to complete the basic worksystem software installation.

This procedure takes about 2 hours using a tape drive. For further assistance, refer to the *Guide to Installing ULTRIX*.

When the installation is complete, the login screen with the DIGITAL logo appears on your monitor.

Remove the tape from the drive after completing the installation. Follow the instructions in the tape drive owner's guide.

## To install the worksystem software from a compact disc drive

1. Remove the ULTRIX software installation compact disc from your ULTRIX optical compact disc kit (refer to the *Guide to Installing ULTRIX* for the full name of the installation compact disc).
2. Load the software installation compact disc into the drive. (The owner's manual for the drive explains how to insert and remove discs.)

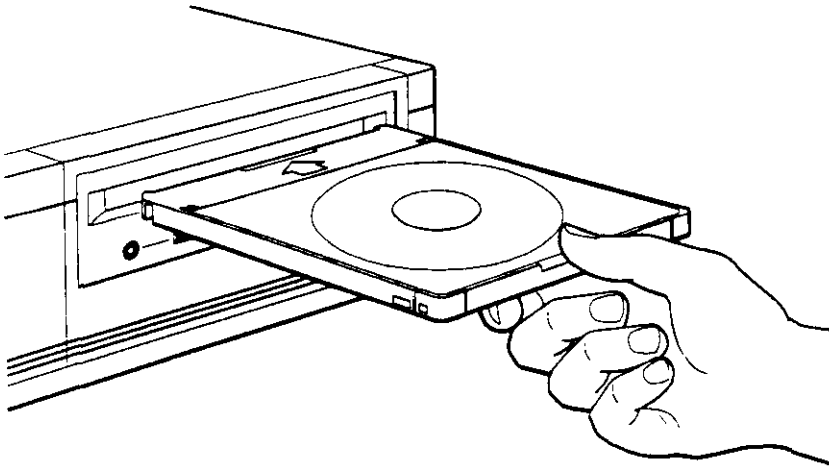

WS3PI053

Figure 46. Loading the software installation compact disc

3. Find the device code and SCSI ID assigned to your compact disc drive.

At the console prompt (>>), type **cnfg slot-number**, replacing *slot-number* with the number of the slot in which the compact disc drive is installed (0, 1, 2, or 3). For example, if the compact disc drive is attached to the base system (slot 3) SCSI connector, type **cnfg 3**. Then press Return.

Here is the relevant portion of a sample display:

```
>>cnfg 3
3:  KN03-AA   DEC   X2.0d   TCF0   (224 MB,   1 MB NVRAM)
                                     (enet: 08-00-2b-0f-45-72)
                                     (SCSI = 7)
```

DEV	PID	VID	REV	SCSI DEV
rz0	RZ55 (C) DEC	DEC	0700	DIR
rz2	RZ24 (C) DEC	DEC	0700	DIR
rz4	RRD42 (C) DEC	DEC	0700	CD-ROM
tz5				SEQ

The drive with the CD-ROM device description in the SCSI DEV column is the optical compact disc drive. To find its device code, look at the entry on the same line in the column labeled DEV. In this example, the CD-ROM device code is `rz4`.

4. After the green indicator light stops glowing, at the console prompt (`>>`) type **boot slot-number/device\_code/vmunix**, replacing *slot-number* with the CD-ROM's slot number and *device-code* with the CD-ROM's device code from the DEV column of the display. Then press Return. For the drive in the example, you would type **boot 3/rz4/vmunix**.
5. Follow the instructions that appear on the screen to complete the basic worksystem software installation.

This procedure takes about an hour using a compact disc drive. For further assistance, refer to the *Guide to Installing ULTRIX*.

When the installation is complete, the login screen with the DIGITAL logo appears on your monitor.

To remove the compact disc from the device drive after completing the installation, follow the instructions in the disc drive owner's guide.

© Digital Equipment Corporation 1991  
All Rights Reserved  
Printed in the U.S.A.