

Testing of the NSC Electronics Module with the GSI Clover Detector

Rakesh Kumar¹, P. Queiroz², H.-J. Wollersheim² (Tutor)

¹Inter University Accelerator Centre
Aruna Asaf Ali Marg
Post Box No 10502
New Delhi 110067
India

Summer Student Program 2005
²Gesellschaft für Schwerionenforschung
Planckstraße 1
D-64291 Darmstadt
Germany

This report refers to the testing of the NSC (Nuclear Science Centre, New Delhi) Electronics Module for Clover Ge-detectors performed at the RISING (Rare Isotope Spectroscopic INvestigation at GSI) group in GSI. The aim of this investigation is to compare its performance with that of a conventional electronics apparatus.

1 Introduction

This paper examines the results of the tests performed on the NSC Electronics Module for Clover Ge-detectors. These investigations were performed at GSI and their goal is to compare the behaviour of the NSC Module with that of a conventional electronic module.

In the following sections, information regarding the setting, the electronics and the performance characteristics for both NSC Module and conventional electronics (energy and time resolutions) is to be found.

2 Materials and Methods

The detector used was the EURISYS MESURES 4 fold segmented Super Clover detector N° 101 of the VEGA-array (Versatile and Efficient GAMMA Detector). The first Clover Detector was developed in France by EURISYS MESURES in the frame of the EUROGAM collaboration. It consists of four coaxial N-type Germanium detectors, arranged in a four leaf clover shape. Each Germanium crystal has a length of 140 mm and a square front face with two flat parts at 90° along

the whole length and two tapered parts at an angle of 15°. Its output signals' characteristic values are presented in Table ?? . The detector was delivered to the GSI (Gesellschaft für Schwerionenforschung, Darmstadt) laboratory in April 1997 [?].

The NSC Module aims to replace the various electronics modules necessary to operate a Clover Detector in a double width NIM mode. This is achieved by placing all the necessary components into one single module capable of handling four channels, i.e., 4 TFA (Time Filter Amplifier), 4 CFD (Constant Fraction Discriminator), 4 main amplifiers (with 3 μ s shaping constant), 4 gate generators and a coincidence unit [?]. The NSC Module arrived at GSI in 2005.

The results for the Clover detector read out were obtained with the four channels of the NSC Module and with the conventional electronics channel.

Each channel has to be connected to one of the four detector contacts. Table ?? shows the correspondence between the detector's centre contacts (black, blue, green and red) and the electronics channels (both from the NSC Module and the conventional electronics).

Tab. 1: Properties of the signals from the Clover Detector.

Detector Contact	Rise Time ns	Fall Time μ s	Under-shoot %
Black	120 ± 60	80 ± 10	2 ± 1
Blue	120 ± 60	80 ± 10	3 ± 1.5
Green	130 ± 70	80 ± 10	1.5 ± 0.5
Red	120 ± 60	80 ± 15	2 ± 1

The ^{60}Co γ -source (which has two well known transitions at 1173 and 1333 keV [?]) was attached to a plastic detector and placed before the front face of the crystals (at a 15-25 cm distance). The plastic detector served as a trigger for the electronics, as it has a very good time resolution (~ 1 ns), although a very poor energy resolution.

^{60}Co β^- -decays into ^{60}Ni through a cascade of two E2 transitions:

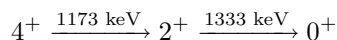

This process results in two almost simultaneous γ -rays being emitted, since the 4^+ and the 2^+ states are very short-lived ($\tau \lesssim 1$ ps). When one of the γ -rays hits the plastic detector and another one hits one of the Ge-detectors, the electronics are triggered (using the AND unit and TRIGGER 2, as in Figure ??). A delayed Ge-detector signal is then used as a stop.

Several different sets of measurements were taken, both by varying the threshold value and the CFD delay for the Ge-detectors. The threshold values used were the normal one (cutting just the noise) and the maximum one (cutting the Compton edge and leaving only the two photo-peaks).

LEA software was used to acquire the spectra and to analyse them.

3 Results and Discussion

3.1 Resolution

3.1.1 Energy Resolution

The energy resolution was measured with an ADC (**A**nalog to **D**igital **C**onverter). Its calibration was done by adjusting Gaussian curves

Tab. 2: Correspondence between electronic channels, detector contacts and TDC and ADC inputs.

Electr. Channel	Detector Contact	ADC Input	TDC Input
NSC A	Black	ENERGY1	TIME1
NSC B	Blue	ENERGY2	TIME2
NSC C	Green	ENERGY3	TIME3
NSC D	Red	ENERGY4	TIME4
conv.	Black ^a	ENERGY5	TIME5

^a In some parts of the experiment, the conventional electronics channel was connected to different detector contacts. In those cases, this is clearly stated.

Tab. 3: Calibration of the ADC and of the TDC for the various channels.

Electronics Channel	ADC keV/channel	TDC ns/channel
NSC A	1.44	0.24
NSC B	1.53	0.25
NSC C	1.16	0.26
NSC D	1.56	0.24
conv.	0.54	0.28

to the two photo-peaks of ^{60}Co and taking the distance between their mean values (given in ADC channels) as 160 keV (Table ??).

The results obtained for the energy resolution can be found in Table 4. It can be observed that there are no major variations for the two different threshold values.

Initially there was an undershoot in the output signal and this was not adjustable from the front panel potentiometer. The polezero adjustment problem was corrected by replacing the fixed value of the feedback resistor 15k Ω in the shaping amplifier polezero circuit with a variable 50k Ω potentiometer. It was observed that the polezero could be corrected by varying the potentiometer to a value of 13.5k Ω . All the daughter cards were replaced by two 27k Ω resistors used in parallel to get 13.5k Ω . The resolution testing was done and it was found that the FWHM is same in both the cases. The Base Line Restorer (BLR) should be adjusted in order to get better resolution. Results for the Conven-

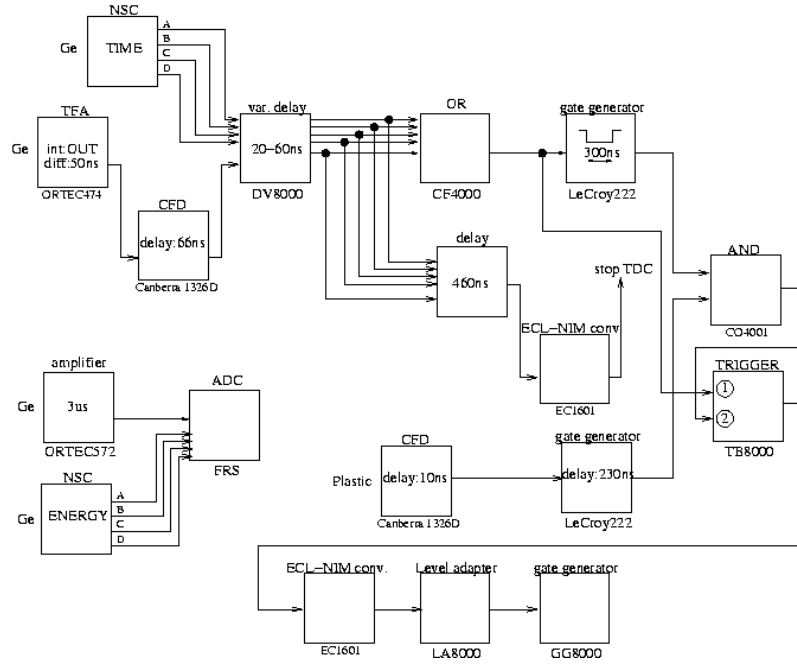

Fig. 1: Electronics block diagram.

tionla electronics (conv) and for NSC's modules Module1 (NSC 1) and Module2 (NSC2) are tabulated in in Table 4.

Tab. 4: Energy resolution for the conventional electronics and NSC's module with ^{60}Co Source .

	Energy resolution at 1332 KeV		
	conv keV	NSC 1 keV	NSC 2 keV
BLACK	3.2	3.2	3.2
BLUE	3.2	3.2	3.2
GREEN	2.9	2.9	2.9
RED	3.2	3.2	3.2

3.1.2 Time Resolution

The time resolution was measured using first a TDC (Time to Digital Converter) and later a TAC (Time to Amplifier Converter).

Both the TDC (Table ??) and the TAC were calibrated using a pulse generator. The distance between the mean values of two peaks that are 24 ns apart was taken as a reference.

In Table ?? are the results for the TDC. The data for the maximum threshold value was not

collected simultaneously, but for one NSC Module channel at a time. The conventional electronics channel was connected to the same detector contact as the NSC Module channel for every measurement.

The conventional electronics channel presents a rather worse resolution for both cases. Concerning the normal threshold value, the possibility that the CFD of the Ge-detectors has a smaller ideal delay was investigated and the results can be found in Table ???. For a 32 ns delay the resolution of the conventional electronics is similar to that of the NSC module. For 20 ns it worsens again.

For the maximum threshold value another problem arises: the CFD starts working in a LE (Leading Edge) mode, which deteriorates the quality of the spectra. When the TDC delay is increased, the spectra deteriorates even further.

The results for the TAC are very similar, and therefore not interesting.

3.2 Spectra

3.2.1 Energy Spectra

Figures ?? and ?? are examples of some of the energy spectra collected with the conventional electronics. The spectra from the NSC module look essentially the same.

Tab. 5: *Time resolution. For the maximum threshold value the conventional electronics channel (TIME5) was connected for every measurement to the same detector contact as the NSC Module channel.*

Channel	FWMH (ns)		
	Normal Thr.	Maximum Thr.	
		NSC	conv.
TIME1	11.4	6.7	12.1
TIME2	8.3	5.6	14.2
TIME3	10.2	5.2	13.1
TIME4	10.9	6.2	8.9
TIME5	15.1	-	-

Tab. 6: *Time resolution from the conventional electronics channel using different CFD delays and detector contacts.*

Detector Contact	CFD delay (ns)		
	Conv	NSC 1	NSC 2
Black	-	7.0	15.1
Blue	-	7.0	-
Green	-	9.8	-
Red	13.2	10.1	13.3

As desired, with the maximum threshold value (Figure ??) the Compton edge is no longer present, but the two photo-peaks can still very clearly be seen.

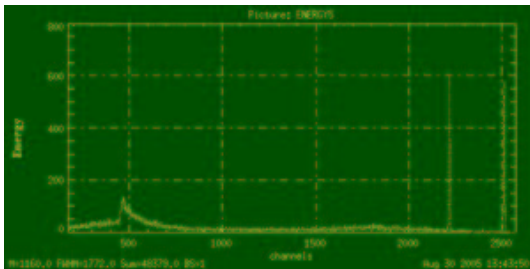

Fig. 2: *Energy spectrum from the conventional electronics channel with normal threshold.*

3.2.2 Time Spectra

Figures ??, ?? and ?? are examples of the time spectra collected.

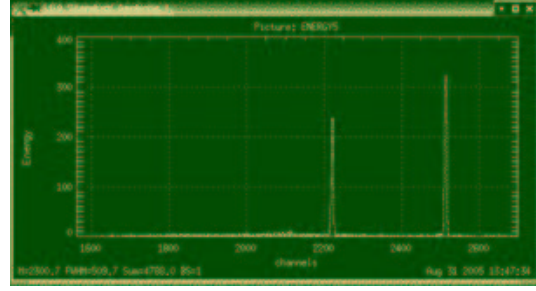

Fig. 3: *Energy spectrum from the conventional electronics channel with maximum threshold.*

Figure ?? refers to the conventional electronics.

In Figure ?? one can see unexpected smaller peaks in the NSC module normal threshold spectrum, which disappear in Figure ?? with the setting of the maximum threshold. The tests are not conclusive enough to establish a reason for this behaviour.

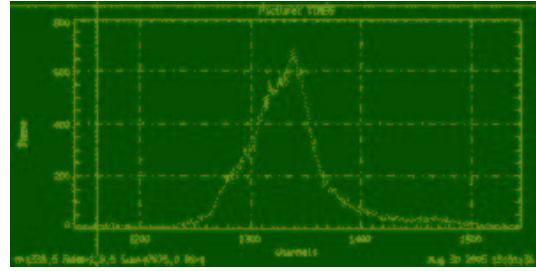

Fig. 4: *Time spectrum from the conventional electronics channel with normal threshold and a TDC 64 ns delay.*

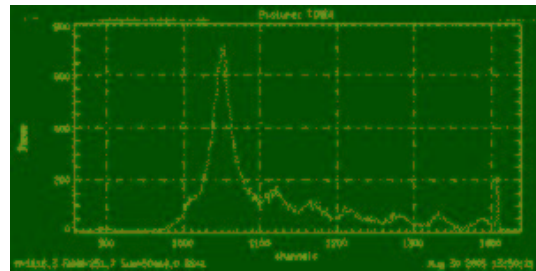

Fig. 5: *Time spectrum from the NDC module channel D with normal threshold.*

References

- [1] Y. Kopach and H.-J. Wollersheim, *Testing of the GSI Clover Detector under Experimental Conditions*, Gesellschaft für Schwerionenforschung, Darmstadt (March 2000).

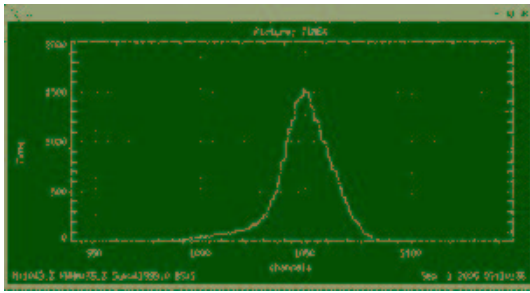

Fig. 6: Time spectrum from the NDC module channel D with maximum threshold.

- [2] S. Venkataramanan et al., *Technical Report on Clover Electronics Module*, Nuclear Science Centre, New Delhi (2003).
- [3] S. Eidelman et al., *Particle Physics Booklet*, Particle Data Group (July 2004).